



**WESTERN  
PACIFIC  
REGIONAL  
FISHERY  
MANAGEMENT  
COUNCIL**

**Draft Report of the Western and Central Pacific Ocean  
Purse Seine Bigeye Management Workshop**



**April 8-10, 2015  
Honolulu, Hawai'i**

This page intentionally left blank

Cover photo: International Seafood Sustainability Foundation



**Western and Central Pacific Ocean  
Purse Seine Bigeye Management Workshop**

April 8-10, 2015  
Honolulu, Hawai‘i  
Harbor View Center at Pier 38



**WESTERN  
PACIFIC  
REGIONAL  
FISHERY  
MANAGEMENT  
COUNCIL**



## Report Summary

### Introduction

The Western and Central Pacific Ocean (WCPO) Purse Seine Bigeye Management Workshop was held April 8-10, 2015 in Honolulu. It was convened by the Western Pacific Regional Fishery Management Council, with funding support from the United States National Marine Fisheries Service and the International Seafood Sustainability Foundation. The three-day workshop was attended by around 50 participants that included representation from the purse seine and tuna processing industry and government officials from Asia, Latin America, United States, Pacific Islands, and the European Union, fishery scientists, and representatives of the Western and Central Pacific Fisheries Commission (WCPFC) and Inter-American Tropical Tuna Commission (IATTC; see Attachment 1 for list of participants). Drew Wright, former Executive Director of the WCPFC, served as chair of the workshop.

Bigeye tuna shows a Pacific-wide distribution, and is probably made up of three putative stocks. However, it is assessed and managed separately in the WCPO by the WCPFC and in the Eastern Pacific Ocean by the IATTC. In the WCPO, bigeye tuna is assessed to be subject to overfishing and is overfished in regards to the WCPFC biomass limit reference point. In the EPO, bigeye tuna is not subject to overfishing, and a preliminary update to the previous IATTC bigeye tuna assessment indicates the stock is not overfished. The two commissions utilize bigeye stock assessments that differ significantly in terms of key assumptions, which can result in different stock status determinations. The Secretariat of the Pacific Community (SPC) is collaborating with the IATTC and others to produce a Pacific-wide bigeye stock assessment, which is scheduled for completion by mid-2015.

Although longline and other fisheries contribute to bigeye overfishing in the WCPO, the WCPO purse seine bigeye tuna catch is at record levels. There was a general recognition in the workshop that existing WCPFC conservation and management measures have not been effective in restricting the purse seine catch of bigeye tuna to acceptable levels with regards to sustainability. There is a need to either refine existing measures, or develop new or supplementary measures that are effective in reducing bigeye tuna fishing mortality. Workshop participants noted that conservation and management measures should not be overly complicated in terms of either interpretation or implementation, promote high levels of compliance, and developed in a manner that does not result in the transfer of a disproportionate conservation burden onto Small Island Developing States (SIDS).

The scope of the workshop was to discuss and assess issues associated with the possible implementation of WCPO purse seine bigeye tuna management measures, either individually or as a suite of measures for purse seine fisheries. The objective of the workshop was to identify a set of options that could be considered and further developed to address purse seine bigeye tuna fishing mortality in the WCPO. The contributions of other fishing gears to reduce bigeye tuna catches in the WCPO should also be considered in follow-on workshops and in developing effective management measures to end bigeye overfishing.

The Workshop provided an opportunity for the purse seine industry and other participants to evaluate management options in an informal, non-commission meeting setting that served to promote the free exchange of views and ideas. The management options considered fell under the following five categories: 1) Temporal-Spatial, 2) Bigeye Catch Limits, 3) FAD-based, 4) Gear Modifications, and 5) Market-based (see Attachment 2 for workshop agenda). During the first two days, each theme was introduced to the Workshop by experts followed by an exchange of views by participants. The third day of the Workshop involved qualitative evaluations of the various management options in small breakout groups.

### **Background Information**

Representatives from the WCPFC and IATTC provided an overview the existing WCPFC and IATTC management measures that govern the catch of bigeye tuna by purse seine vessels operating in the WCPO and EPO. The WCPFC conservation and measure (CMM 2014-01) requires a seasonal FAD closure of three months plus a FAD set limit or a four-month FAD closure (July-October).

In the IATTC area, under resolution C-13-01, large-scale purse vessels are subject to a seasonal total closure of 62 days, whereby vessels choose one of two periods to apply the closure (29 July to 28 September or 18 November to 18 January). There is also a seasonal closure of an area west of the Galapagos Islands from 20 September to 20 October. In addition, the IATTC has a closed vessel register to limit fishing capacity in the purse seine fishery.

Two areas highlighted by participants as differences between the two RFMO management regimes include: (1) that the IATTC's measures are linked to estimated levels of active fishing vessel capacity and (2) that there are no exemptions in the IATTC measure. In addition, it was generally recognized that the IATTC measure is relatively simple to interpret and enforce.

The WCPFC measure was assessed by some to be overly-complicated, that it contains too many exemptions, and that there is poor compliance with the seasonal FAD closure. Measures that are practical to implement and lend themselves to ease for monitoring and detecting non-compliance were preferred. An overarching concern identified among industry participants was purse seine overcapacity in the WCPO.

Presentations by the SPC highlighted that in the WCPO, total purse seine bigeye tuna catches peak at mid-longitudinal regions (i.e. 140° E - 170° E), where most of the purse seine effort is concentrated, even though there is a greater reliance on FAD sets in the Central Pacific. Purse seine bigeye tuna catch per unit effort steadily increases moving toward the east, and increases substantially east of 180°. Approximately 10 % of purse seine bigeye tuna catches in the WCPO come from the high seas, the remainder is caught in EEZs of Pacific Island countries. Longline vessels generally catch sub-adult and adult bigeye, whereas purse seine vessels mostly impact small, juvenile bigeye; however it is generally understood that both fisheries are equally responsible for the level of spawning biomass currently observed.

Participants identified the accuracy of purse seine bigeye tuna catch reporting as a significant concern, given that logbook estimates are generally underestimated, observer grab samples contain inherent biases, and cannery identification of bigeye tuna under 3.5 kg is typically poor.

## **Evaluation of WCPO Purse Seine Bigeye Management Options**

The following provides a summary of major points identified and discussed in relation to workshop presentations and the evaluation of management options under several categories.

### ***Temporal-spatial measures***

Area-based measures have the potential to reduce bigeye tuna fishing mortality. Hotspots with respect to purse seine bigeye tuna catch (western Pacific) and CPUE (central equatorial Pacific) have been identified; however, these hotspots do not overlap. The consideration of bigeye tuna hotspots as a management option needs to take into account the movement of fish, the importance of limiting the displacement of fishing effort, and potential impacts to all countries with regards to the location of area closures.

### ***Bigeye Catch Limits***

The establishment of purse seine bigeye tuna catch limits within the WCPFC would be challenging to monitor and enforce, but it does offer a direct approach to addressing purse seine bigeye tuna fishing mortality. An important issue associated with purse seine catch limits is the accurate estimation of bigeye tuna catches, which largely involves the ability to distinguish between small yellowfin and bigeye tuna, and perhaps more so, the ability to detect a small percentage of bigeye tuna within a large mixed-haul of skipjack and yellowfin. However, it was identified that 28% of the WCPO purse seine bigeye tuna catch comes from sets that are comprised of at least 50% bigeye tuna, which indicates large sets of mostly bigeye tuna do occur. In addition, there are between 9 and 14 vessels that are responsible for up to 25% of the WCPO purse seine bigeye tuna catch. Further investigation of the accuracy of bigeye catch estimates and operational aspects of these select vessels could lead to practical technical solutions to reduce purse seine bigeye tuna catches.

Purse seine bigeye tuna catch limits have the potential to act as a disincentive that could change fishers' behavior. The ability to discern the species composition of tuna aggregations on FADs prior setting would give fishers the capability to avoid aggregations with large percentages of bigeye tuna. While sonar and echosounder equipment is effective in estimating fish biomass, it does not yet provide for clear species identification. Recently completed ISSF research in collaboration with industry have identified the acoustic target strength for skipjack and bigeye tuna, with research on yellowfin target strength planned for 2105.

The IATTC has been investigating individual purse seine vessel bigeye tuna catch limits for several years. Recent work has identified the need to establish an Individual Vessel Quota rate to address the differences in a vessel's fishing capacity with respect to individual quotas. Further evaluation in the IATTC is focusing on various implementation issues associated with vessel limits such as allowing fishing in other locations, opportunistic FAD fishing by vessels with little FAD history, and estimation and enforcement considerations.

The development of purse seine bigeye tuna catch limits within the WCPFC would require the establishment of a Total Allowable Catch (TAC). The allocation of a TAC among CCMs could be a lengthy, politically-charged negotiation that would likely involve the consideration of flag State catch history and aspirational limits associated with SIDS and Participating Territories.

Decision-making with respect to allocations of a TAC require consensus by the WCPFC. If the WCPFC did agree on allocations of a purse seine bigeye tuna TAC, a CMM could be faced with several national-level choices on how it would choose to implement the measure. Advances in electronic reporting in the WCPO may benefit the monitoring of vessel quotas.

### ***Gear Modifications***

A technological solution to reduce or eliminate the incidental catch of bigeye tuna by purse seine gear is also possible. Unfortunately, the “silver bullet” that would solve the problem has yet to be found. Investigation into purse seine net depth has shown substantial differences between net depth in the EPO (shallower) versus in the WCPO (deeper), which is related to thermocline depth and water clarity. Mandating a minimum net depth would be problematic for vessels that operate in both regions, as it would require complicated monitoring and lend itself to compliance issues. Research has shown that bigeye tuna are generally found lower in the water column than skipjack and yellowfin, but still well above the lowest position of the net at an effective fishing depth. Requiring shallower nets in the WCPO could make unassociated school fish sets more difficult as deeper nets are needed to reduce fish escapement. More research is needed on other gear modifications such as light or sound stimuli.

Some fleets have shown a substantial shift away from dependence on FADs to more free school fishing. Several Japanese purse seine vessels that use to a knotless netting have changed to a larger mesh size net that increases sinking rates by approximately 7 %. In addition, vessels have been outfitted with more powerful winches to increase net pursing speed, generally reducing pursing time from 45 minutes to 20 minutes. Both gear modifications are used to increase free school fishing efficiency, which has reduced FAD sets and associated bigeye tuna catches in this fleet.

### ***FAD-based measures***

Analysis of the WCPFC seasonal FAD closure indicates that in its absence, purse seine bigeye tuna catches on average would be approximately 25% greater; thus, the FAD closure is working, but likely not to desired levels. One identified problem is that the WCPFC measure does not require FADs to be removed during the closure period, thus the ability for FADs to “soak” during the FAD closure and accumulate fish may be limiting the effectiveness of the measure. Significant bigeye catches are routinely observed in the month following the FAD closure. In addition, the deployment of FADs by non-purse seine vessels during FAD closure may also be having an impact by “soaking” FADs that aggregate tuna, which are then fished soon after the closure ends.

There was significant discussion on the lack of FAD information in the WCPO, for example, how many FADs are deployed annually, how many are deployed per vessel, and how are FADs equipped with echosounders utilized. It was noted that more information FADs could affect the scientific evaluation of stocks, in particular if the acoustic information generated from instrumented FADs was available for scientific purposes.

Currently, there are no separate fees associated with fishing access agreements for fishing on FADs. The PNA is considering a FAD-pricing mechanism to incentivize a reduction in the number of FAD sets in the WCPO. The revenue produced by the FAD-pricing scheme could be

used to address disproportionate burden issues associated with bigeye tuna conservation and SIDS. In order for a FAD pricing system to be effective, the WCPFC would need to agree on compatible measures for the high seas, the longline fishery, and measures for non-PNA EEZs. On average, FADs are believed to produce higher purse seine catch rates at lower costs; however, industry representatives voiced concern that given the current the price of skipjack, FAD pricing in combination with the VDS and other operating costs could pose significant economic challenges for purse seine vessels.

### ***Market-based measures***

Bigeye is not a good product for canning, with a texture, color, and taste that is off-putting to consumers. Bigeye receive the same price as skipjack and yellowfin in 1.8 to 3.4 kg range, and in some markets the same price of skipjack and yellowfin up to 10 kg. In the United States, bigeye tuna can be mixed with skipjack and yellowfin in “light meat” packs, with no requirements to identify species on the can. In the past, the US light meat market was able to absorb purse seine bigeye tuna catches within mixed-species products; however, demand for FAD-free and/or bigeye-free products in some markets is increasing.

There is increased retailer demand for FAD-free products; however, retailer demand for FAD-free products, which may cost 20% more in some markets than conventional products, varies by country. The transfer of payment incentives for the supply of FAD-free product is not consistent, with payment incentives for the crew unlikely to occur when fish prices are low. In addition, FAD-free claims in the marketplace are not always verified through a product chain of custody. The seasonal FAD closure can lead to a glut in free-school supply, further limiting crew incentives due to weak demand during those periods. Sustainability certification and ecolabeling is an increasing market trend in Europe and the United States, although higher profit margins are not guaranteed for the relatively few certified tuna fisheries.

### **Next Steps**

Workshop participants appreciated the informal setting that facilitated the exchange of views on purse seine bigeye tuna management, and the opportunity to identify options to progress the issue in the WCPFC. With the 2015 WCPFC meeting cycle set to begin in July, there is apprehension that the status quo bigeye tuna measures could prevail, which is not good for bigeye tuna nor a good reflection on the WCPFC and its role in managing the world’s largest tuna fishery.

There was general agreement among participants on the utility of another workshop to continue the dialogue and momentum for the identification of new or supplementary purse seine bigeye tuna management measures. Other issues that were identified to be covered in the next workshop include longline management options and addressing disproportionate conservation burden. Glen Joseph offered to host the next workshop in Majuro.



## Table of Contents

Report Summary .....	4
1. Opening of Workshop.....	12
2. Background Information.....	13
2.1 Current Bigeye Management Measures.....	13
2.1.1 Western and Central Pacific Fisheries Commission.....	13
2.1.2 Inter-American Tropical Tuna Commission.....	14
2.2 Bigeye Tuna Stock Status and Purse Seine Catch Trends .....	15
2.2.1 Western and Central Pacific Ocean .....	15
2.2.2. Eastern Pacific Ocean .....	17
2.3. Industry Perspectives .....	19
Lunch Presentation by Victor Restrepo:.....	20
“Capacity of the Large-Scale Tropical Tuna Purse Seine Fishing Fleets (as of April 2015)” .	20
3. WCPO PS BET Management Options .....	22
3.1 Temporal-Spatial Measures .....	22
3.1.1 John Sibert- SEAPODYM Analysis .....	22
3.1.2. Shelton Harley- Spatial Patterns of Purse Seine Bigeye Tuna Catch (Bigeye Hotspots)	23
3.1.3. Kurt Schaefer- Purse Seine Catch Distribution and Movements of Bigeye Tuna in the	27
EPO.....	27
3.2 Bigeye Catch Limits .....	30
3.2.1. David Itano- Pre-set Identification of Bigeye.....	30
3.2.2. Rick Deriso- Individual Purse Seine Vessel Quotas in the EPO .....	32
3.2.3. Shelton Harley- Bigeye Purse Seine Catch Patterns Across Vessels and Sets.....	34
3.2.4. Valerie Chan- Challenges and Opportunities in Developing an Individual Quota	35
System for Bigeye Tuna in the WCPO: A case study of the US Purse Seine Fishery .....	35
3.3. Gear Modifications and Other Technical Options .....	37
3.3.1. Victor Restrepo and David Itano- ISSF Research .....	37
3.3.2. David Itano- Gear Modifications and Other Technical Options.....	38
3.3.3. Yujiro Akatsuka- Gear Modification and Other Technical Options: how Japan has	40
implemented bigeye tuna bycatch reductions .....	40

3.3.4. Taro Kawamoto- A challenge to reduce bycatch of BE tuna by a Japanese tuna purse seiner .....	41
3.4 FAD-based Issues .....	43
3.4.1. John Hampton- Effects of FAD-based Measures in the WCPO.....	43
3.2.4 Wez Norris- Controlling and Reducing FAD Usage Through Pricing.....	45
3.5 Market-Based Initiatives .....	48
3.5.1 Susan Jackson- Bigeye Market Measures: Eastern Pacific, Atlantic, and Indian Oceans .....	48
3.5.2 Kevin Bixler- Asia Pacific Bigeye Markets.....	49
3.5.4. Jim Humphries- Eco-labels and Other Market Driven Incentives.....	50
3.5.5. Matt Owens- Vessel Incentives for Supplying FAD-free Fish.....	51
3.6 Considerations of Other Options and Issues .....	53
4. Workshop Recommendations and Outcomes .....	57
4.1. Workshop Breakouts and Group Reports .....	57
4.1.1. Spatial-temporal measures .....	57
4.1.2. Catch Limit Options.....	60
4.1.3. Gear Modification Measures.....	63
4.1.4 FAD-Based Options.....	65
4.1.5 Market-Based Measures.....	70
5. Workshop Wrap-up and Closing Remarks .....	75
Attachment 1- List of Participants .....	77
Attachment 2- Workshop Agenda .....	78

## **Preface:**

This report was drafted to follow the workshop agenda. It provides an overview of the workshop presentations and identifies key points and figures from the five thematic areas. Participant questions and comments are reflected to provide a detailed record of the meeting.

## **Preparer:**

This report was prepared by:

Eric K. Kingma  
Intl. Fisheries, Enforcement, and NEPA Coordinator  
Western Pacific Fishery Management Council  
1164 Bishop St. Suite 1400  
Honolulu, HI 96813  
(808) 522-8141  
Eric.Kingma@noaa.gov  
www.wpcouncil.org

## **Acknowledgements:**

Workshop Steering Committee:

Angela Martini  
Brian Hallman  
Drew Wright  
Kitty Simonds  
Rafael Trujillo  
Susan Jackson  
Wez Norris

Workshop Technical Committee:

David Itano  
Eric Kingma  
Holly Kohler  
John Hampton  
Paul Dalzell

Western Pacific Regional Fishery  
Management Council staff:

Asuka Ishizaki  
Ellie Granger  
Jordan Takekawa  
Rebecca Walker

## 1. Opening of Workshop

Drew Wright, workshop Chair, began the workshop with a welcome and introductions.

Kitty Simonds provided opening remarks, highlighting that the subject of the workshop is the preeminent issue in the tropical tuna management today. Bigeye overfishing is not a new problem, as it existed during the series of Multilateral High-Level Conferences (MHLC) that led to the signing of the Honolulu Convention in 2000 and the establishment of the Western and Central Pacific Fisheries Commission. During the MHLC period, there was optimism that bigeye tuna overfishing would have been solved by now, but that goal has not been realized.

Simonds referred participants to the resolution at the Fourth Session of the MHLC (1998) which encouraged all States and other entities concerned to exercise reasonable restraint in respect of any expansion of fishing effort and capacity in the WCPO. Since that time, there has been a nearly linear increase in the amount of catch, effort, and number of purse-seine vessels operating in the WCPO, resulting in now what is the world's largest tuna fishery. She asked participants to imagine a scenario without a bigeye tuna problem with regards to how far could these fisheries go, and what potential economic gains could be derived to all parties involved.

Simonds stated that thinking of the situation as the bigeye tuna problem is no longer acceptable, but rather, it is the defining challenge in the current history of Pacific tropical tuna fisheries. To solve it will require international cooperation. She concluded that the purpose of the workshop will explore and evaluate several potential purse seine bigeye tuna management options with the end goal of identifying solutions to address the bigeye tuna challenge.

Drew Wright provided an overview of the workshop agenda by briefly describing the topics that will be covered in detail by several presenters. He identified that the workshop was not a meeting of the WCPFC, but an informal gathering with participation from the purse seine and tuna processing industries, from which he was looking forward to their substantial contribution to the discussion. Wright mentioned that while the focus of the workshop was on purse seine fishing gear, there is general recognition that purse seine fisheries are not the only gear contributing to bigeye tuna overfishing in the WCPO, and that there will be a need for fair and equitable contributions from other gears to reduce bigeye tuna overfishing.

Wright identified that the scope of the workshop was to discuss and assess issues associated with the possible implementation of WCPO purse seine bigeye tuna management measures, either individually or as a suite of measures for purse seine fisheries. The objective of the workshop was to develop a set of options that identify possible measures that can be considered for reducing the purse seine bigeye tuna fishing mortality in the WCPO, and in particular, to evaluate those options in an informal setting. The evaluation of the various management options will take into account conservation benefits, implementation issues, and monitoring and compliance.

He closed by stating that his workshop is a real opportunity to get the industry's perspective on management measures, and that the outcomes may be applicable to other ocean basins.

## **2. Background Information**

### **2.1 Current Bigeye Management Measures**

#### **2.1.1 Western and Central Pacific Fisheries Commission**

Lara Manarangi–Trott, WCPFC Compliance Manager, presented on existing WCPFC conservation and management measures (CMMs) that relate to bigeye tuna management in the WCPO. She briefly described the history of the WCPFC, identifying the MHL process that was initiated in 1994 and completed in 2000 with the signing of the Honolulu Convention. There are 40 international participants to the WCPFC, comprised of 26 member governments, 7 participating territories, and 7 cooperating non-members. An important feature within the Commission is that most of the fishing takes place in the national waters of Pacific Island Countries.

There are 14 CMMs in force, which range from monitoring, control and surveillance to measures that focus on target species and non-target species. The WCPFC has agreed on several non-binding resolutions and other decisions related to the conservation and management of HMS stocks in the region.

Within the WCPFC Convention Area, skipjack tuna is the predominate catch harvested by purse seine vessels. The catch of bigeye tuna represents about 6% of the total catch of tunas in the Convention Area, and is harvested by longline, purse seine and other gears. Although a relatively small proportion of the total WCPO tuna catch, the overfishing of bigeye tuna has been an issue of concern within the WCPFC since its establishment. One of the first agreements made by the WCPFC was a resolution (2004-04) on the establishment of a workplan for the WCPFC to adopt a tropical tuna CMM in 2005.

Manarangi-Trott explained how WCPFC management provisions are essentially built upon the foundations of earlier CMMs. In 2008, the WCPFC agreed on CMM 2008-01, which contained a package of measures that attempted to achieve a balance between the purse seine and longline fisheries to reduce bigeye tuna fishing mortality. For example, it put in to place a 3 month FAD closure, catch retention for purse seine vessels, 100% purse seine observer coverage, and flag-based longline bigeye tuna catch limits. In 2011, the CMM was essentially a roll-over, including the removal of the Western High Seas Pockets 1 and 2 closures. In 2012 and 2013, there were further refinements to the measure, and what we had in 2014 was essentially what was agreed in 2013.

Leading up to the December 2014 WCPFC meeting in Apia, the scientific advice to the WCPFC was that bigeye tuna is very likely overfished and fishing mortality must be reduced, and further that yellowfin and skipjack should not see an increase in catch. The WCPFC agreed on CMM 2014-01 which includes, like previous CMMs, recognition of the PNA purse seine Vessel Day Scheme (VDS), non-PNA EEZ effort limits, and 2015 High Seas limits purse seine effort limits. The measure includes a 3 month (July, August, September) FAD closure for all countries, but also an option that countries can choose to either implement a fourth month (October) FAD closure or apply an annual FAD set limit to its purse seine vessels. Korea, FSM, and Japan have

notified the WCPFC Secretariat that they will implement the 3-month FAD closure plus their respective annual FAD set limits for 2015. The remainder of CCMs will be implementing the 4-month FAD closure for 2015. It was originally envisaged that there would be a five-month FAD closure subject to Paragraph 15 in the CMM, but there was not agreement that the 5-month FAD closure transferred a disproportionate conservation burden onto SIDS and Participating Territories, so the 4-month FAD closure was maintained for 2015.

Manarangi–Trott described the bigeye tuna longline flag-based catch limits, which include monthly reporting requirements to the WCPFC. Flag-based longline catch limits do not apply to SIDS and Participating Territories to allow for development of their fisheries. The last section of CMM 2014-01 relates to other fisheries (e.g. handline) that exceed tuna catches greater than 2,000 metric tons of either bigeye, yellowfin or skipjack tuna, whereby those fisheries are subject to a limit on the number of vessels or fishing effort limits.

Outstanding issues for the WCPFC's next regular session meeting occurring in December in Bali with respect to tropical tuna management, include potential yellowfin limits, capacity management work plan, and addressing disproportion conservation burden on SIDS and Participating Territories.

### **2.1.2 Inter-American Tropical Tuna Commission**

Guillermo Compean, Director of the IATTC, presented on bigeye tuna conservation measures in the Eastern Pacific Ocean (EPO), which have been in place for the last 17 years. The first resolution, in 1998, was a bigeye tuna total allowable catch limit of 45,000 metric tons, which if reached, purse seine FAD fishing was prohibited. The limit was not reached in 1998. The following year, the bigeye tuna TAC was set at 40,000 mt, which was met in November 1999, and FAD fishing was prohibited for remainder of calendar year. There was also a cap on the total catch of yellowfin (approximately 240, 000 mt). In 2002, the IATTC agreed on a closure of the entire EPO, which was modified in 2004-2007, whereby the closure was implemented during two different periods, August to September and all of December. Flag-based longline limits apply to countries that catch more than 500 mt by their vessels greater than 24 meters. None of the longline limits for the major longline fleets have been reached.

The 2014-2016 IATTC measure for purse seiners is a total closure for a period of 62 days, with a choice from two different periods in the year, 29 July to 28 September or 18 November to 18 January. Countries have to notify the Secretariat which closure period they will apply to their vessels, with the name of vessel and closure period identified on the IATTC website. The current measure also includes a seasonal closed area to the west of the Galapagos Islands, from 20 September to 20 October. During the closure period, purse seine vessels not in transit are required to be in port, which makes monitoring easy.

Compean stated that the measures apply in both the high seas and in waters of national jurisdiction, and there are no exemptions to the area of application, with the exception of small vessels. For example, Class 1-3 purse seine vessels or if less than 182 ton carrying capacity are exempted from the measure, as are pole and line, troll, and sports fishing vessels. Collectively, bigeye catches from these fleets make up less than 4% of the total EPO bigeye tuna catch.

Compean indicated that the measure includes an annual review based on the latest stock assessments, and can be adjusted for both purse seine and longline fisheries if there is an identified conservation need.

**Discuss points:**

- General recognition that the IATTC transitioned away from quota limits to a total closure due to:
  - Potential misidentification of yellowfin and bigeye and catch estimate accuracy.
  - Greater industry acceptance with regards to compliance.

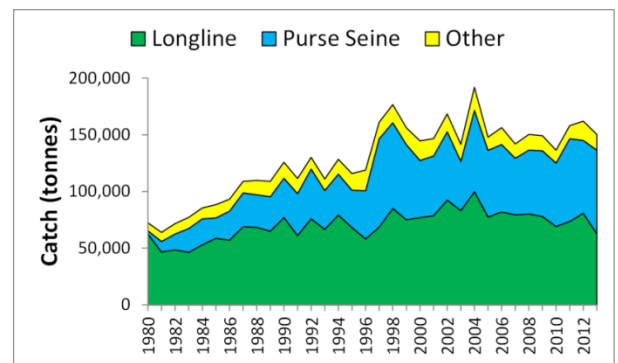
**2.2 Bigeye Tuna Stock Status and Purse Seine Catch Trends**

**2.2.1 Western and Central Pacific Ocean**

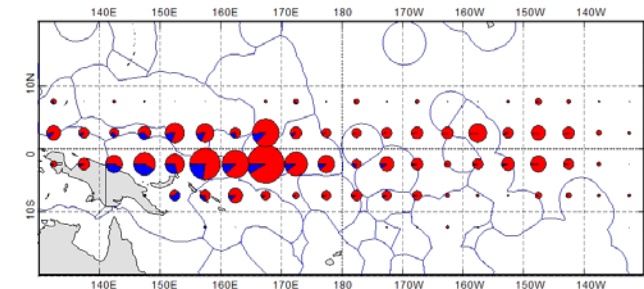
John Hampton, Manager, Oceanic Fisheries Programme (SPC), presented catch statistics and the stock status of bigeye tuna in the WCPO. The total bigeye tuna catch has been fairly stable since the late 1990s, which has occurred in spite of increases in effort by all major fishing gear types, particularly purse seine and longline. Even with the increases in purse seine fishing vessel numbers, fishing days, technology, bigger boats, etc., the ability to take more bigeye tuna out of the system is unlikely. In recent years, the purse seine fishery is catching around the same amount (in weight) as the longline fisheries, which is stark contrast to the early days of the purse seine fishery. The advent of FADs use in the purse seine fishery is responsible for this change.

With regard to the size composition of the bigeye tuna catch, the longline fishery takes larger, mostly adult size bigeye tuna, and the purse seine fishery takes predominately small, mostly juvenile sizes of bigeye tuna. Over 90 percent of purse seine bigeye tuna catch comes from fishing on FAD-associated sets.

Total purse seine bigeye tuna catch peaks at mid-longitudinal regions (i.e. 140° E - 170° E), where most of the purse seine effort is concentrated, even though there is a greater reliance on FAD sets in the Central Pacific, and more unassociated sets in the Western Pacific (Figure 2). However, purse seine bigeye tuna catch per set steadily increases moving toward the east, and increases substantially from 180° (Figure 3). It appears bigeye tuna is more vulnerable to purse seine fishing moving east, where it is possibly more abundant in schools. Although purse seine effort is relatively low in the central equatorial

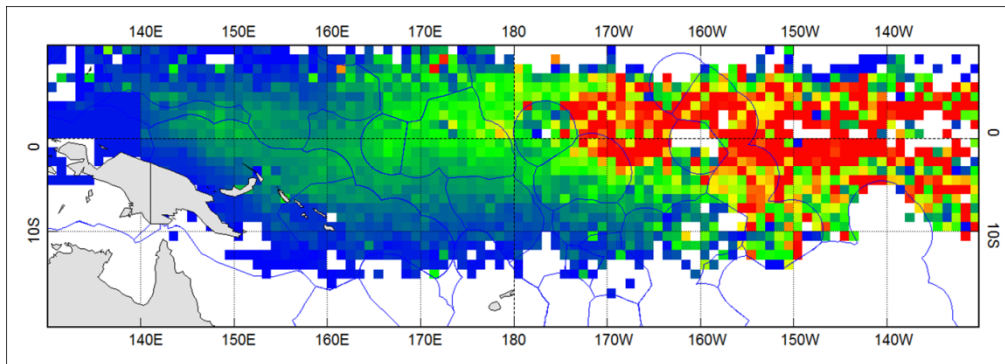


**Figure 1: WCPO Bigeye Catch**  
Source: John Hampton



**Figure 2: Purse Seine Bigeye Catch**  
Note: blue = catch; red= catch per set  
Source: John Hampton

Pacific, if there was build up in effort in this area, greater catches of bigeye tuna would be observed due to high purse seine bigeye tuna CPUE levels in this region.



**Figure 3: Purse Seine Bigeye CPUE (2003-2012)**

Note: blue= low CPUE; red= high CPUE

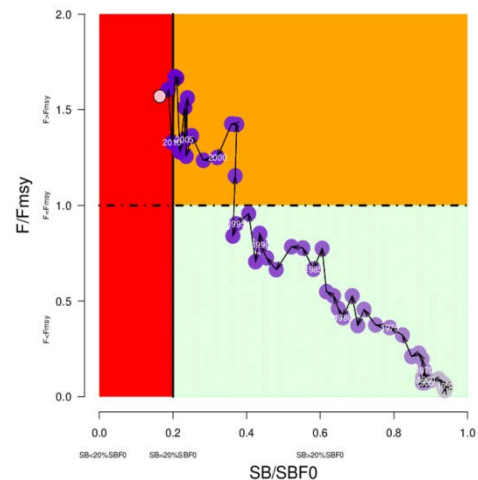
Source: John Hampton

Historically, the percentage of purse seine bigeye tuna catch that came from the high seas was between 20 and 30 percent; however, after CMM 2008-01 that included the temporary high seas pocket closure and other WCPFC management decisions (e.g. high seas effort limits), the high seas purse seine bigeye tuna catch is now around 10 percent, with the remainder coming from waters under national jurisdiction.

Hampton presented information from the 2014 WCPO bigeye tuna stock assessment. The spawning biomass of bigeye tuna shows a fairly steady and continuous decrease in recent years. The current level of fishing impact on the spawning biomass is in excess of 80 percent, resulting in the spawning stock biomass to be below the 0.2 limit reference point agreed to by the WCPFC.

The impact of longline and purse seine gears on the stock is roughly equivalent, with both fisheries responsible for the level of spawning biomass depletion currently observed. As seen in the Majuro Plot, total bigeye tuna fishing mortality is somewhere in excess of 50% of maximum sustainable yield (MSY) and spawning biomass is below 0.2 limit reference point level (Figure 4).

WCPFC management measures need to do two things, reduce fishing mortality to levels associated with MSY, and increase spawning biomass above the limit reference point. As part of the SPC's stock assessment work, projections are run using a range of assumptions to test what might occur under certain management scenarios. Projecting 2012 bigeye tuna catch and effort levels forward, and using estimates of recent-average



**Figure 4: Majuro Plot: WCPO bigeye Stock Status:**



recruitment, there is 32 percent risk of falling below the limit reference point of 0.2.

It was noted that the WCPFC decides the level of risk, but guidance from the convention establishing the WCPFC indicates preference for having low probabilities of exceeding limit reference points. If projecting CMM 2013-01, including the assumption of a five-month FAD closure and scheduled longline catch reductions, there is a 4 percent risk of falling below the limit reference point. Not all provisions of the measure were able to be incorporated into the projections due to uncertainty (e.g. effect of high seas effort limits), so the outcome is an example of the methodology.

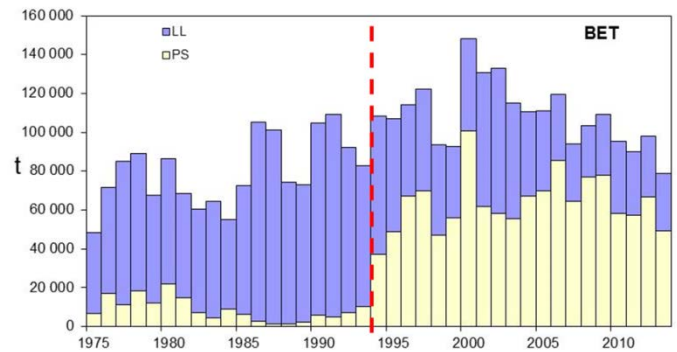
### **Discussion Points:**

- It was recognized that there is uncertainty in a number of different biological aspects of the stocks (e.g. natural mortality) and when dealing with MSY-based quantities, the stock recruitment steepness is a sensitive parameter.
  - To account for uncertainty, stock assessments are run with multiple models with varying parameter values which provide probability distributions of results.
- It was noted that bigeye recruitment is driven by a range of environmental factors.

### **2.2.2. Eastern Pacific Ocean**

Rick Deriso, Chief Scientist (IATTC), started his presentation with providing the trend of bigeye tuna catches from 1975 to 2013, and noted that the purse seine FAD fishery began in 1994 (Figure 5).

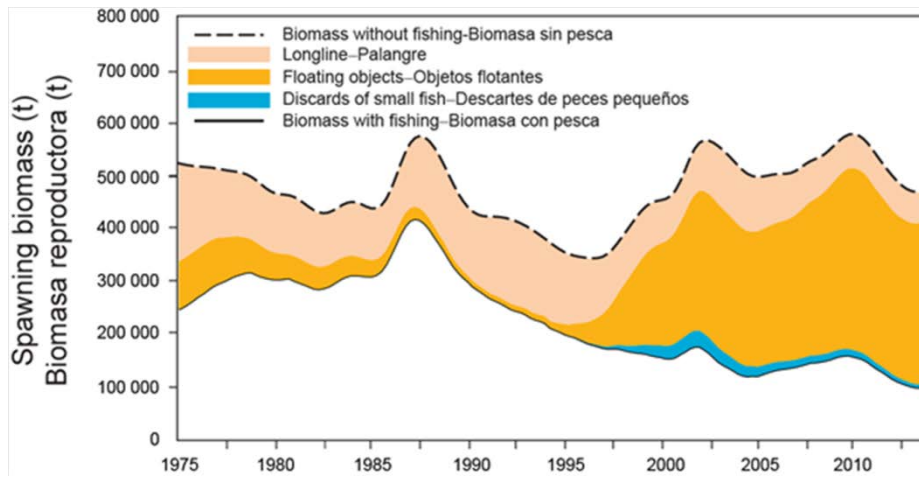
After the introduction of the FADs in the purse seine fishery, the age-specific fishing mortality changed considerably, with peak fishing mortality occurring at several quarters younger than before FAD use. Environmental factors influence recruitment variability, particularly El Niño, where recruitment peaked in 1983 and 1993, which were strong El Niño years. Bigeye recruitment in the EPO was above average from 2001-2006 below the average in 2007-2009, and fluctuated around the average from 2010 to 2013.



**Figure 5: EPO Bigeye Catch**  
Source: Rick Deriso

The EPO bigeye tuna stock assessment assumes a stock recruitment relationship steepness value of 1.0 as its base case, but also uses 0.75 for sensitivity analysis. The assumption of steepness greatly affects what is believed to be the status of the stock, whereas the steepness value of 1.0 is considerably more optimistic than a 0.75 value. For example, while the MSY estimates are similar between the two steepness values, the biomass at MSY ( $B_{MSY}$ ) using as steepness value of 0.75 is nearly twice as large as the estimate of  $B_{MSY}$  when using a value of 1.0. To conduct the WCPO bigeye tuna assessment, the SPC assumes a steepness value of 0.8, which is a striking difference from the IATTC assessment.

With respect to fishery impact, the purse seine FAD fishery is dominating in terms of removals and impact on the resource (Figure 5).

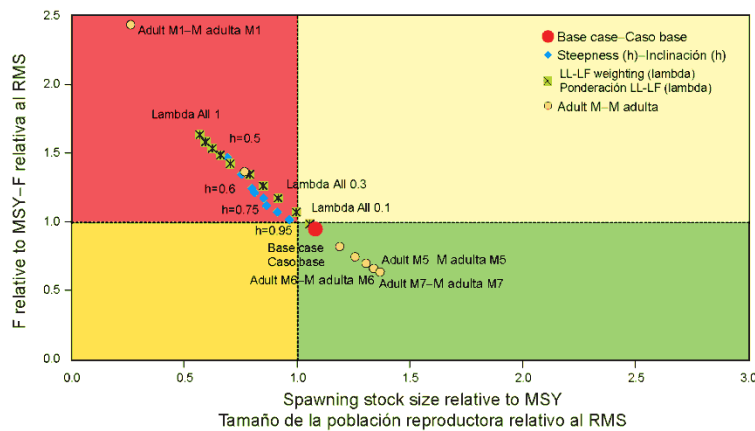


**Figure 5: Fishery Impact on EPO Bigeye**

Source: Rick Deriso

A preliminary update to the previous stock assessment indicates that bigeye tuna spawning biomass is currently above MSY level (not overfished), whereas it was under the MSY level and the stock was considered slightly overfished last year. Like the previous assessment, bigeye tuna overfishing is not occurring in the EPO (Figure 6).

Deriso concluded by stating that the stock status interpretations are highly sensitive to various assumptions related to the steepness of the stock-recruitment relations, adult natural mortality levels, and size composition data weighting.



**Figure 6: EPO Bigeye Stock Status “Kobe Plot”**

Source: Rick Deriso

### **Discussion Points:**

- Recognition of the sensitivity of stock status results with respect to using different assessment parameters, in particular the difference in steepness values used for the bigeye stock recruitment relationship between the IATTC and WCPFC bigeye stock assessments.
- Acknowledgement that model assumptions can impact stock status determinations, i.e. overfished or not, and how small differences in model assumptions can trigger the need for stricter conservation and management measures.
- Recognition of the importance that fishery managers have a range of information available for setting risk levels with regards exceed target or limit reference points.

### **2.3. Industry Perspectives**

K.S. Lee, Executive Director (SILLA Co., Ltd.) presented his perspective on effective conservation management measures for tropical tunas and in particular bigeye tuna. He commented that there are five main problems with current conservation and management measures. First, the measures too complicated, citing VDS, seasonal FAD closures, high seas effort limits, longline catch limits etc. Second, there are too many competing stakeholders interests, which make agreeing on measures difficult. Third, there are too many exceptions, whereby he questioned the difference between an exemption and a loophole. He commented that the exemptions in the IATTC make up approximately 4 percent of the total catch, whereas in the WCPFC, exemptions result in 30% of the bigeye tuna catch. Fourth, the issue of transparency and/or inconsistent application of measures are important. For example, the definition of a FAD may include any floating object, but there have been instances where an observer has categorized a floating plastic bag as a FAD. This indicates that the definitions are not very clear and are too complicated. Lastly, most conservation and management measures are not drafted by fishermen and do not take into account on-the-water realities.

Lee showed data indicating that prior to 2010, the Korean purse seine fleet catch of bigeye tuna was less than 500 mt per year; however, in 2014 the Korean purse seine fleet caught 1,100 mt of bigeye tuna. The increase in bigeye tuna catch is attributed to vessels doing more FAD fishing, because school fishing has been poor, which Lee attributed to the recent increase in purse seine vessel capacity. He reiterated that the main problem with the conservation and management measure is the lack of capacity control.

Lee reviewed a chart of management options that were evaluated based on perceived conservation benefits, implementation impacts, and enforceability. For example, the Vessel Day Scheme (VDS) encourages fishermen to increase fishing power, which could undermine its effectiveness; similarly, a total allowable catch (TAC) is useless if implementation fails. All types of measures fail if there are exemptions. Lee said that the priority for the new measure should be that it is simple and easy to implement, and that it is enforceable.

Effective CMMs					
	Time Closure	Fad Closure	VDS	TAC	Capacity Freezing
Conservation	○	△	△	○	○
Implementation	○	△	△	×	○
Enforcing	○	×	△	△	○
Eco-friendly	○	○	△	○	○
Market value	○	△	×	○	○
With exemption	×	×	×	×	×

He concluded that everyone must equally share the burden and the benefit.

**Figure 6: Korean Industry Evaluation of Effective CMMs**

Source: KS Lee

**Discussion Points:**

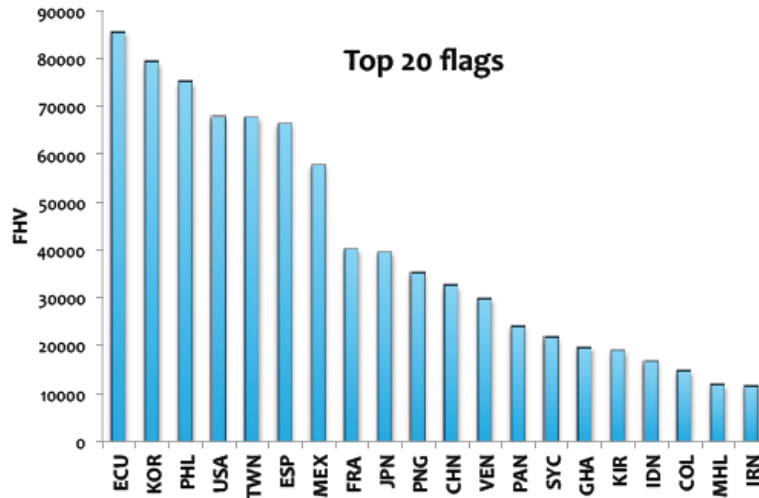
- Recognition that simple, clear, enforceable measures are critically important in international fisheries management.
- Acknowledgement that exemptions weaken any measure, and that it is problematic within the WCPFC, whereas exemptions in some form apply to nearly all members of the Commission.

**Lunch Presentation by Victor Restrepo:**

**“Capacity of the Large-Scale Tropical Tuna Purse Seine Fishing Fleets (as of April 2015)”**

Victor Restrepo, Vice President-Science (ISSF), presented on the worldwide capacity of purse seine vessel fleets fishing for tropical tunas. The information was compiled from Tuna RFMO vessel lists; however, two important fishing capacity metrics are often missing from those lists: a) fish hold volume, and b) fish carrying capacity. There 1,955 purse seine vessels listed under the RFMO vessel lists, but not all are fishing for tropical tunas (e.g. small vessels fishing for Mediterranean bluefin). After taking this into account and only considering large-scale purse seine vessels with a fish hold volume of greater than 335m<sup>3</sup>, there are 759 large-scale tropical tuna purse seine vessels on RFMO lists. The same analysis conducted in 2014 resulted in the number of vessels at 795, thus there has been a 10 percent increase in the number of vessels over the last year.

Ten countries concentrate 67% of the large-scale purse seine fishing capacity, with Ecuador leading the group (Figure 7).



**Figure 7: Global large-scale tropical tuna purse seine vessel capacity by country**  
Source: Victor Restrepo

An important consideration is that there are regularly more vessels registered with an RFMO than are operating within its jurisdiction. This indicates that many fleets are global in nature, but also highlights that there is potential for capacity displacement. For example, if one RFMO limits capacity, it is likely that vessels could move elsewhere in a legal manner. With respect to fishing capacity transfer, vessel flag changes are not always readily available, but ISSF’s review found that approximately 90 percent of transfers have been from developed countries to developing countries or between developing countries.

There are slightly more than 300 purse seine vessels operating in the WCPO. Globally, there have been 75 new purse seiners built since 2010, with 52 of them operating in the WCPO, which indicates the importance of the area (Figure 8). Restrepo concluded that overcapacity is long-term problem, leading to overexploitation and wasted resources.

	2010	2011	2012	2013	2014	
Cape Verde					1	1
China, P.R.		3	3		3	9
Chinese Taipei	1		4	4	2	11
Ecuador	1				1	2
Fed. States Micronesia	1					1
France	2		2			4
Japan				2		2
Kiribati					1	1
Korea, Rep.	1		4	1	4	10
Marshall Islands	4					4
Mauritius				2		2
Mexico				2	4	6
Panama					1	1
Papua New Guinea				3	5	8
Philippines	2		1	1	2	6
Seychelles					4	4
Spain				1	1	2
Venezuela					1	1
<b>Grand Total</b>	<b>12</b>	<b>3</b>	<b>14</b>	<b>16</b>	<b>30</b>	<b>75</b>
						WCPCF: 52

**Figure 8: Construction of large-scale tropical tuna purse seine vessels, 2010-2014**  
Source: Victor Restrepo

### **Discussion Points:**

- Recognition that the new vessels entering the WCPO are significantly larger than the ones being replaced and are estimated to be equivalent to 40 additional purse seine vessels
  - Newer purse seine vessels likely have greater fishing power and efficiency.
- Views were expressed that the WCPFC capacity limit and March 1, 2015 deadline to notify new vessel construction was self-defeating, resulting in a rush of new vessels being built.
  - It was recognized that more information on vessel replacements and fish hold capacity will likely be provided at the WCPFC meeting in December.
  - It was identified that the development of the WCPFC Capacity Management Work Plan should help clarify the capacity limits.
- A view was provided that the VDS has allowed for vessel capacity growth, and as more vessels enter the fishery, the VDS price has gone up. As vessel owners pay more for per day under the VDS, it has resulted in an incentive to use FADs to catch more fish, which means less school fishing, and more dependence on FAD fishing.

### **3. WCPO PS BET Management Options**

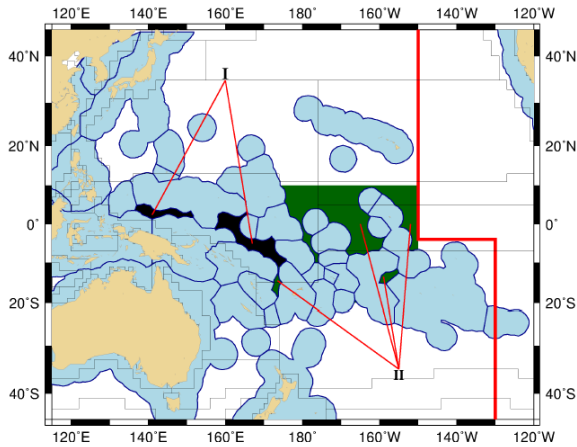
#### **3.1 Temporal-Spatial Measures**

##### **3.1.1 John Sibert- SEAPODYM Analysis**

John Sibert, Fish Population Modeler, presented work he did with colleagues using the Spatial Ecosystem and Population Dynamics Model (SEAPODYM) to simulate historical expansion of the bigeye tuna WCPO fishery from 1980 to 2003. Various scenarios were analyzed including purse seine area closures with and without redistribution of effort, purse seine effort reductions, longline closed area, total FAD prohibition, and various combinations these scenarios (Figure 8).

The results were evaluated in terms of change in biomass over the simulation period, ratio of exploited to unexploited biomass (i.e. fishery impact), and conservation efficiency with regards to increase in bigeye tuna biomass but reduced skipjack catches. Results indicate that area-based measures in combination with other measures (e.g. no displacement of fishing effort) can benefit the bigeye tuna stock, but it will require reductions in catch, which comes at a cost.

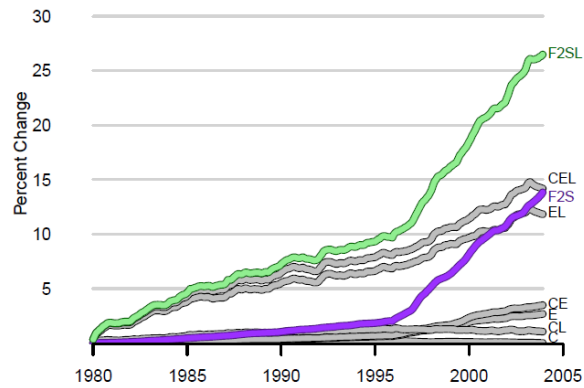
Based on the study, the scenario that had the largest impact on bigeye tuna stock biomass was prohibiting the use of FADs in the convention area and closing high seas in central-equatorial area to longline fishing. Other scenarios that would improve the bigeye tuna stock include closing high sea pockets to purse seine fishing and closing high seas in central-equatorial area to longline fishing, or a reduction in purse seine fishing effort plus longline high seas closure (Figure 9).



**Figure 8: WCPFC Convention Area and Potential Area Closures for Purse seine and Longline Fisheries**

Note: Area I (shaded black)- purse seine closure; Area II (shaded green)- longline closure

Source: John Sibert



**Figure 9: Percent Change in Bigeye Biomass from Various Area Closure and Effort Management Scenarios**

Note: (F2SL)- prohibit FADs + longline closed area; (CEL)- high seas pockets purse seine closure + longline closed area; (EL)- purse seine effort reduction + longline closed area.

Source: John Sibert

Sibert also commented on recent studies<sup>1, 2</sup> that suggest the use of FADs in the purse seine fishery is having an effect on the movement of skipjack. For example, in the 1990's the median displacement distances of a tagged skipjack was 550 miles, whereas now it is around 175 miles. Sibert identified the need manage FADs and to incorporate FAD data into models as well as the need for multispecies models that also address climate change and predicted spatial shifts in productivity.

### **Discussion Points:**

- It was acknowledged that the study could be updated with more recent parameter prioritization including the incorporation of tagging information and a yellowfin model.
  - Adding a yellowfin model would help to understand the impact of bigeye tuna conservation measures with respect yellowfin catches.
- Recognition that the purse seine fishery is a multispecies fishery such that the effect of conservation and management measures on the catches of skipjack, yellowfin, and bigeye is important in understanding the distribution of costs to countries and fisheries.

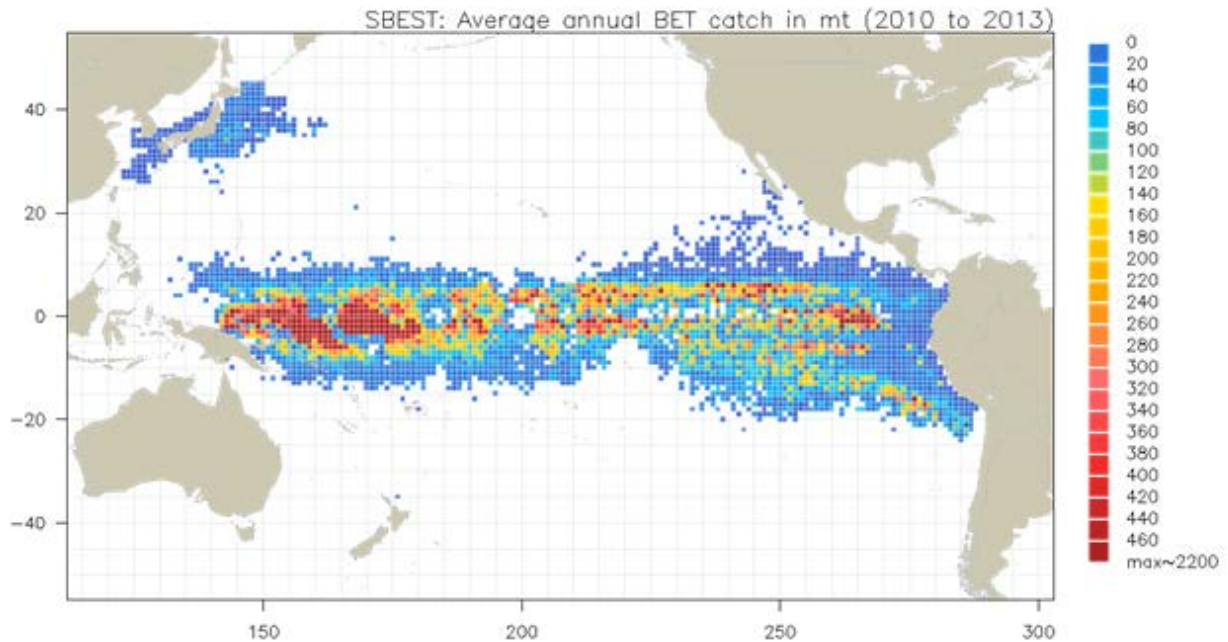
### **3.1.2. Shelton Harley- Spatial Patterns of Purse Seine Bigeye Tuna Catch (Bigeye Hotspots)**

Shelton Harley, Principle Fisheries Scientist (SPC), presented purse seine catch data with respect to the identification of bigeye tuna catch hot spots in the WCPO. The best estimates of bigeye tuna catches by one-degree square are integrated from vessel logbooks, observer grab samples, port sampling, VMS, and correction factors from spill sampling trials. There is often a large discrepancy of bigeye tuna catches from what is reported on logbook versus observer sampling, which is important when considering individual vessel limits.

<sup>1</sup> Wang et al. 2014. The Large-Scale Deployment of Fish Aggregation Devices Alters Environmentally-Based Migratory Behavior of Skipjack Tuna in the Western Pacific Ocean. PLOS ONE, www.plosone.org 2, 9(5):e98226.

<sup>2</sup> Eun Jung Kim, 2015. Doctoral dissertation. University of Hawaii

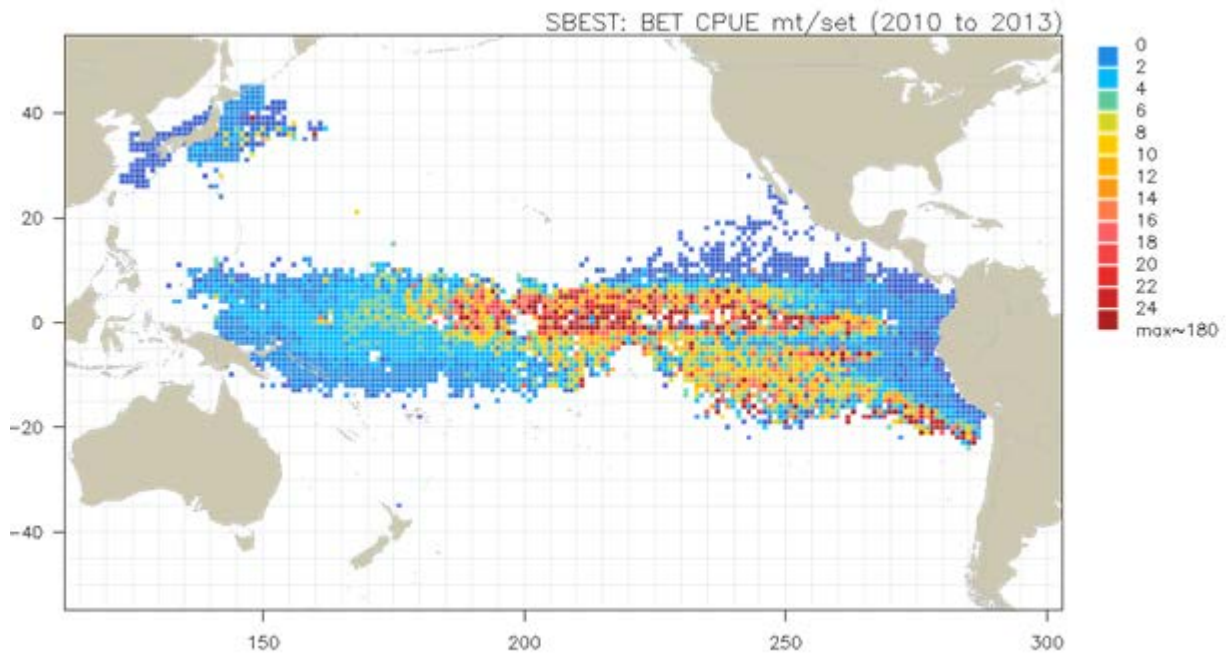
With respect to bigeye tuna catches, the equatorial area of the Western Pacific sees the highest purse effort, but also has the highest bigeye tuna catch; however, the area with the highest bigeye tuna CPUE is in the central equatorial Pacific (Figures 10 and 11). The area with the highest proportion of bigeye tuna per purse seine set is in the eastern Pacific (Figure 12). In areas with high proportions of bigeye tuna catch (e.g. 20 percent), the term bycatch is not appropriate, with bigeye tuna making up an important component of a vessel's retained catch.



**Figure 10: Average Annual Purse Seine Bigeye Catch in the Pacific Ocean, 2010-2013**

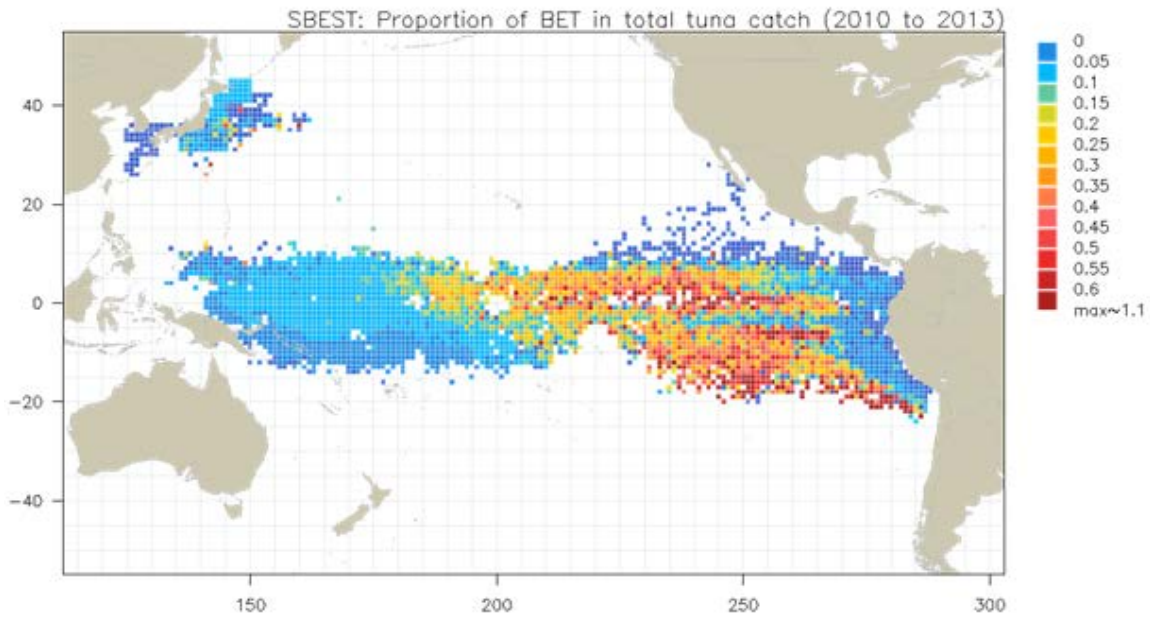
Source: Shelton Harley





**Figure 11: Purse Seine Bigeye Catch Per Unit Effort in the Pacific Ocean, 2010-2013**

Source: Shelton Harley

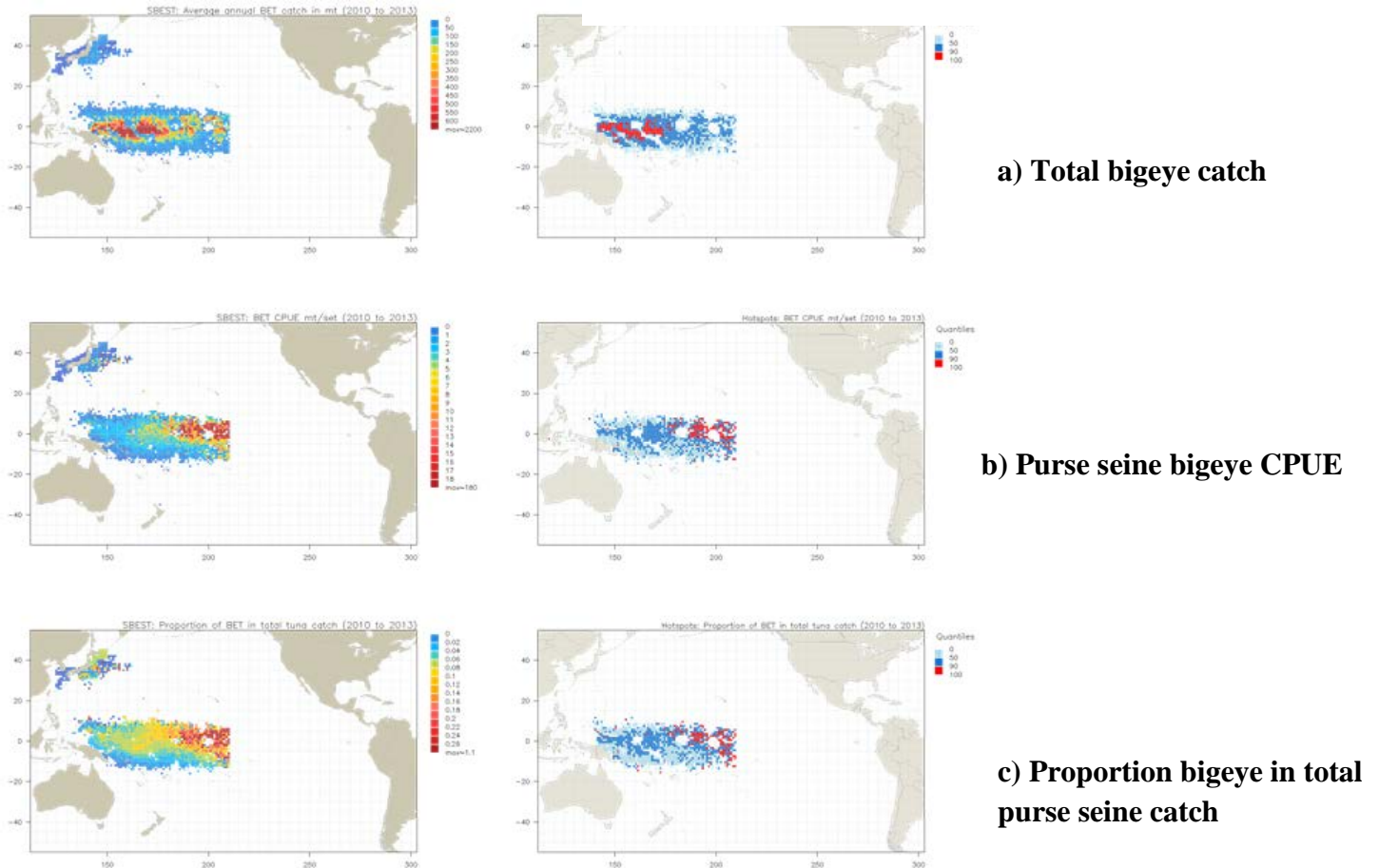


**Figure 12: Proportion of Bigeye in Total Purse Seine Catch, 2010-2103**

Source: Shelton Harley

With respect to identifying bigeye tuna purse seine hotspots, Harley showed areas that spatially represent the top ten percent values of bigeye tuna catch, CPUE, and bigeye tuna proportion of the catch for areas in the WCPO (Figure 13).

## Bigeye Hotspots in the WCPO



**Figure 12: Identified Purse Seine Bigeye Hotspots in the WCPO**

Source: Shelton Harley

Establishing closures to various hot spots would result in differing reductions to bigeye tuna fishing mortality as well as total catch. For example, closing a hot spot area with regards to total bigeye tuna catch would result in a 56 percent reduction in bigeye tuna catches, but also a 57% reduction in the total catch – saving 35,000 tons of bigeye tuna, but costing 800,000 tons of tuna. Other hotspots with respect to bigeye tuna CPUE and proportion in catch could result in approximately 14% reduction in bigeye tuna fishing mortality, but that is assuming the fish are not caught outside the closed areas. Harley stressed the need for considering effort displacement and fish movement in these types of analyses, and referred to future work on the subject listed below:

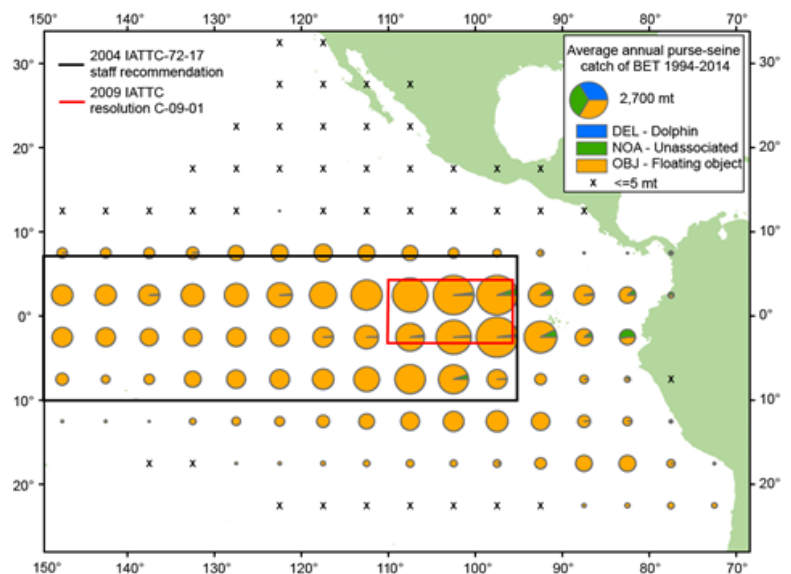
- Examination of bigeye tuna catches in free school sets;
- Examination of contiguous hotspot areas and consistency of hotspots through time;
- Closed area simulations including scenarios of effort reallocation and total versus FAD restrictions;
- Generation of raised estimates of catch and effort at the vessel level;
- Improved species composition estimates at the individual set level, e.g., through hierarchical modelling of sets within the same temporal/spatial strata and/or other data sources; and
- Disaggregating bigeye tuna catches in the observer data set into ‘large’ and ‘small’ and determine if the hotspot areas are similar for all bigeye tuna versus small bigeye tuna.

**Discussion Points:**

- Recognition of the high proportion of the bigeye tuna catch on FADs in the Central and Eastern Pacific, whereby 50% and 60% of the catch is comprised of bigeye tuna.
  - It was identified that if the size of the bigeye caught is the same size as skipjack, there was no price differential between the two offered by canneries.
- Acknowledgement that since 2010, WCPO high seas purse seine catch is approximately 10 percent of the total catch, with most of that occurring in the eastern WCPO high seas and little occurring the western high seas pockets.

**3.1.3. Kurt Schaefer- Purse Seine Catch Distribution and Movements of Bigeye Tuna in the EPO**

Kurt Schaefer, Head of the Biology and Ecosystem Program (IATTC), presented purse seine catch distribution and movements of bigeye tuna relevant to the IATTC Convention area in the EPO. Between 1994 and 2014, the average bigeye tuna catch in the EPO was about 61,000 mt, with 65 % coming from the equatorial zone between 5 degrees north and 5 degrees south latitude. IATTC’s first spatial management measure was established 2003 (31 days), which was increased to 42 days in 2004. Starting in 2009, the IATTC added the spatial closed area with boundaries corresponding to 96 degrees West to 110 Degrees West, 4 degrees North, and 3 degrees South (red box in Figure 13). Up until 2008, approximately 24% of bigeye tuna caught in the EPO was within those boundaries. From 2009-2014, the boundary area represented 13 percent of the total bigeye tuna catch, but this decrease was not solely a result of the seasonal area closure; a change in purse seine catch distribution was also a factor. From an evaluation conducted last year, the one-month seasonal closure of



**Figure 13: EPO Purse Seine Bigeye Catch and Boundaries of the 1-month Seasonal Closed Area**

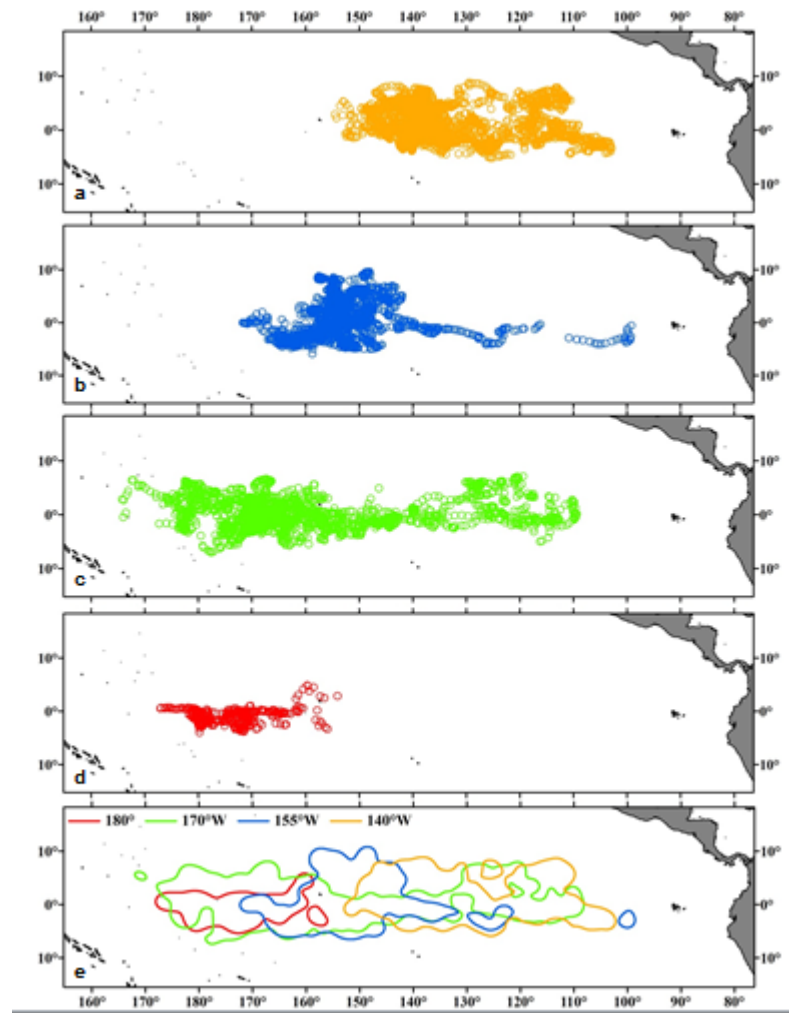
Note: closed area borders indicated in red

Source: Kurt Schaefer

the boundary area is equivalent to a 3-day total closure of the entire IATTC Convention area.

Schaefer presented the historical catches of bigeye tuna by both the purse seine and longline fisheries. In 1993, the longline bigeye tuna catch was around 73,000 mt, with purse seine gear catching approximately 10,000 mt of bigeye tuna. The EPO purse seine fishery began using FADs in 1994, and caught 35,000 mt of bigeye tuna that year. Purse seine bigeye tuna catch in the EPO peaked in 2000 at 95,000 mt, and in 2013, 49,000 mt of bigeye tuna was caught the purse seine fishery (less than the 67,000 mt historical average). On the other hand, the longline fishery caught 33,000 mt of bigeye in 2013. In recent years, there has been a steep increase in the number of FAD sets by purse seine vessels, with a 60 percent increase in FAD sets since 2008 within the 5 degrees N and 5 degrees S latitude.

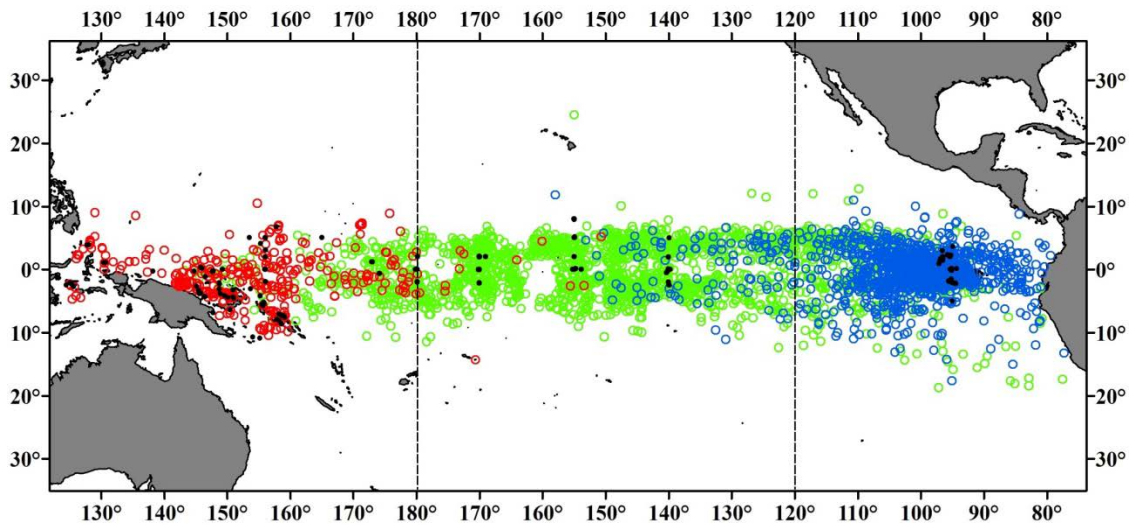
Schaefer also presented the latest information on bigeye tuna movement derived from tagging studies that occurred in the Central Equatorial Pacific. Bigeye tuna tagged in the equatorial zone have high fidelity to the equatorial zone, as it is a productive area due the dynamic equatorial current system that produces horizontal and vertical structure that results in high concentrations of prey (e.g. squid and mesopelagic fish). Bigeye exhibit latitudinally-constrained movement between 10 degrees North and 10 degrees, and a general eastward longitudinal dispersion pattern, in particular from fish tagged around 170 degrees W (Figure 14). The results of tagging studies indicate considerable mixing of bigeye tuna between the equatorial regions of the WCPFC and IATTC Convention Areas (Figure 15).



**Figure 14: Position Estimates for Archival Tagged Bigeye**

Note: Data shown are for fish at liberty for more than 30 days, and released at the following locations: (a) 140°W (fish = 16,  $n = 2,434$ ), (b) 155°W (fish = 15,  $n = 1,704$ ), (c) 170°W (fish = 15,  $n = 2,225$ ), (d) 180° (fish = 2,  $n = 324$ ), and (e) 95 percent volume contours for all positions by release longitude

Source: Kurt Schaefer

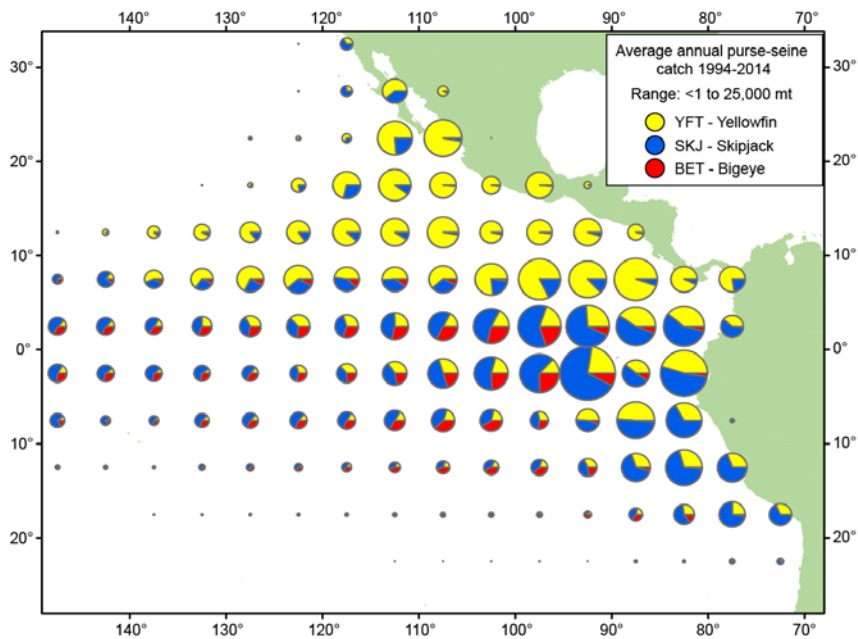


**Figure 15: Bigeye Dart Tag Recapture Positions**

Note: Data is shown for fish at liberty beyond 30 days, and color coded by area of release. Dashed longitudinal lines are putative stock boundaries between 180 degrees and 120 degrees W.

Source: Kurt Schaefer

Schaefer reported that within equatorial zone located between 5 degrees North and 5 degrees South latitude, bigeye tuna comprises 16 percent of the purse seine catch east of 100 degrees West, but comprises 36 percent of the catch west of 100 degrees West, which is important to recognize when considering spatial and temporal closures and tradeoffs between bigeye tuna conservation and impacts on skipjack catch (Figure 16).



**Figure 16: Average Annual Purse Seine Catch of Yellowfin, Skipjack, and Bigeye in the Eastern Pacific Ocean, 1994-2014**

Source: Kurt Schaefer

### **Discussion Points:**

- There was recognition of the recent purse seine FAD activity off Peru (south of 10 degrees South), but that those FAD sets predominately catch skipjack and yellowfin and not bigeye tuna.
- Acknowledgement of an increasing trend in EPO FAD sets since 2008, but the trend in skipjack catches do not follow a similar increase.
  - A view was expressed that this indicates that some purse seine vessels must be targeting bigeye tuna to maximize catch production.

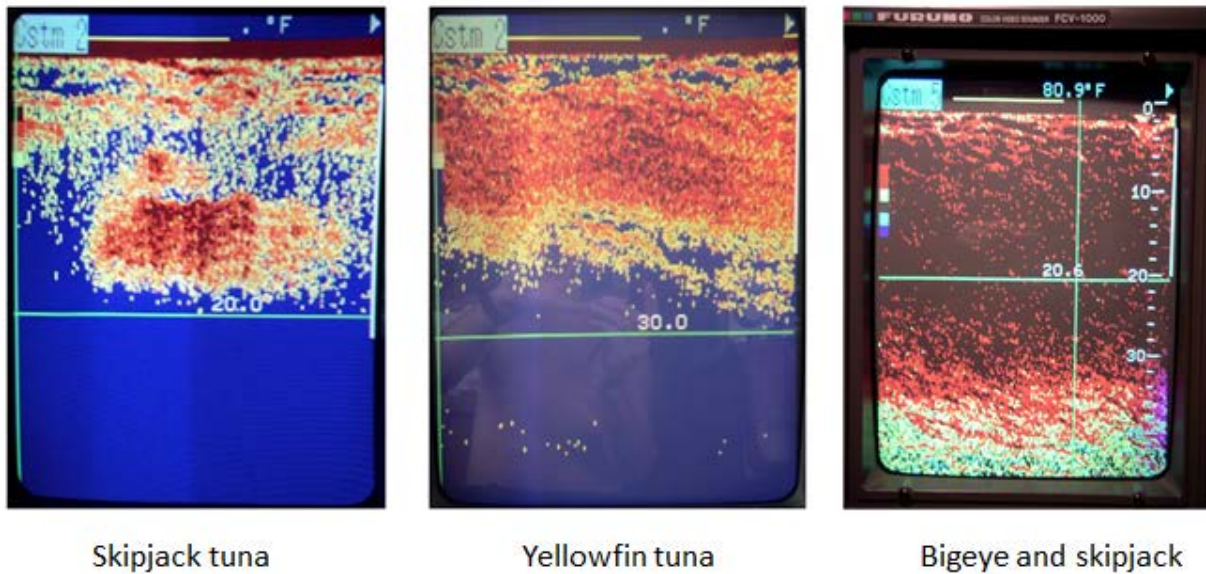
## **3.2 Bigeye Catch Limits**

### **3.2.1. David Itano- Pre-set Identification of Bigeye**

David Itano, Fishery Biologist (Consultant), presented on the latest information with regards to the pre-set identification of bigeye tuna, with a view that if a management measure such as bigeye tuna catch limit was in place, that bigeye tuna could be detected and avoided prior to a set. To identify tuna species using echosounders, there is need to define the acoustic target strength for skipjack, yellowfin, and bigeye tuna, and then develop filters to be able to discern them apart, as well as their individual size. Each of these three tuna species have a different acoustic signature which is linked to their physiology. Skipjack do not have a swimbladder, yellowfin swimbladders occupies half their body cavity, and the swimbladders of bigeye tuna occupy their entire body cavity. Fish with the largest swimbladders reflect echosounder signals the highest, but difficulties arise for example, when comparing a small bigeye to a larger yellowfin with similar swim bladder volumes.

On a recent ISSF research cruise, various transducer frequencies were tested to distinguish target strength values for different species. Skipjack are more discernable on higher frequencies at around 200 kilohertz, whereas bigeye tuna identified better at lower frequencies of 38 kilohertz. Filters were then applied to be able to discern species within mixed species schools. While positive results with respect to target strength for skipjack and bigeye tuna were obtained, more work needs to be done with yellowfin, as the pre-set distinction between yellowfin and bigeye tuna is critically important. In addition, there is a need for the methodology and predictions to be tested against actual catch and compared with detailed on-board species composition sampling. However, the preliminary results are that target strength values are discernable for skipjack and bigeye/yellowfin tuna.

While the ultimate goal is for the technology to be able to distinguish between species at a touch of a button, fishermen have and continue to make good estimates of tuna species and total size of the aggregation with a number of different inputs including: commercially available echosounders, sonar and fish depth distributions, time of day, communication among boats in the area, personal catch history, and local oceanographic information (Figure 17).



**Figure 17: Echosounder image (50 kHz signal) of Tuna Associated on a Drifting Vessel in the Equatorial EPO**

Source: Schaefer and Fuller 2007; David Itano

Itano concluded his talk by discussing echosounder buoys, which in his opinion has revolutionized purse seine fishing world-wide. There are five companies competing in the market and the technology is getting better every year. For example, one company is now making an echosounder buoy with dual frequencies that may have potential for species identification in the future. At this time, however, the consensus from industry is that echosounder buoys can be used to identify biomass of commercially-valuable tuna, but not consistently able to distinguish species. Itano closed by stating that it is likely easier to avoid bigeye tuna if the proportion in the aggregation is high, such as  $\geq 20$ -25 percent, but when the aggregation only contains 4 or 5 percent bigeye tuna like in far Western Pacific, the ability to discriminate bigeye tuna at that percentage is not possible.

**Discussion Points:**

- Industry participants acknowledged that on-board echosounders can help distinguish species and sonar is used to help estimate biomass; however, nothing is 100 percent effective at this time.
- It was recognized that technological limitations may not be the same in all regions. For example, the size of bigeye tuna caught in the Western Pacific are smaller than the bigeye tuna caught in the Central and Eastern Pacific, with small fish being harder to distinguish – bigeye tuna swimbladders are not well developed until the fish is over 40 centimeters.
- There was general agreement that knowing the species composition beneath a FAD will not discourage the purse seine vessels from making FAD sets unless there is an incentive (e.g. catch limit) to not catch bigeye.

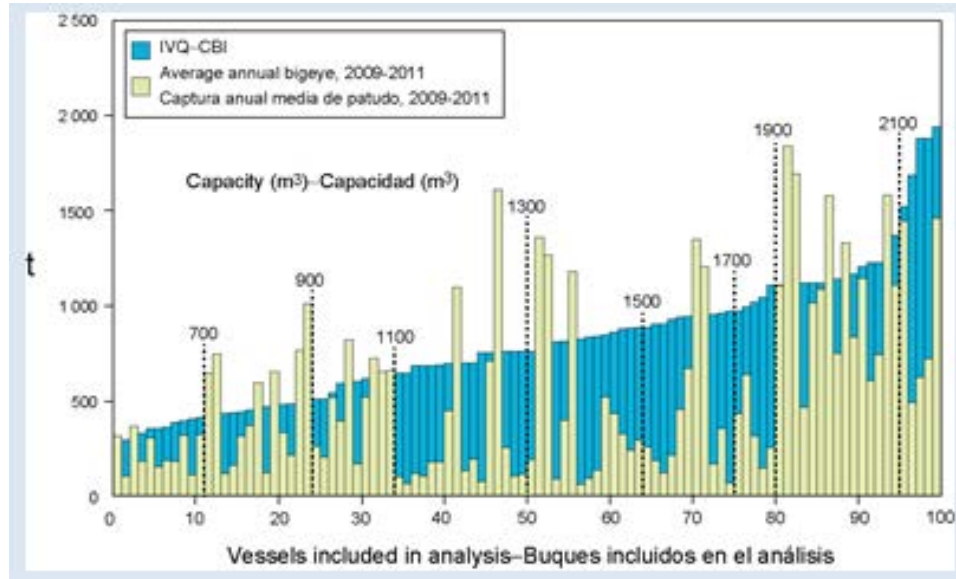
### **3.2.2. Rick Deriso- Individual Purse Seine Vessel Quotas in the EPO**

Rick Deriso provided a presentation on individual bigeye tuna vessel quotas for purse seine vessels that fish on FADs in the EPO. The analysis was restricted to vessels that caught an average of at least 50 metric tons of bigeye tuna annually between 2009 and 2011, which was a total of 100 vessels out of 207 purse seine vessels active in the IATTC Convention Area. These 100 vessels averaged a total of 50,656 tons of bigeye tuna or 80% of the total EPO purse seine bigeye tuna catch, whereas the same vessels accounted for 13% of the total purse seine yellowfin catch.

The analyses were performed for bigeye tuna in isolation and for bigeye tuna and yellowfin in combination for the same 100 vessels. Yellowfin was included in the IVQ analysis for several reasons, including: (1) distinguishing small yellowfin from bigeye tuna can be difficult at sea; (2) conservation of yellowfin of the small sizes generally caught in floating-object sets is an appropriate management goal. The IVQs were calculated by multiplying a vessel's capacity by an IVQ rate, which is a calculated quantity designed to make the projected total catch by the fleet equal to the target catch for achieving the desired conservation goal. For a given number of days of closure, the projected catch is the lesser of (a) the vessel's IVQ or (b) its total estimated catch of bigeye tuna and yellowfin combined during the allowable days of fishing.

Based on the analysis, a short closure period would result in the lowest IVQ rate, whereas a longer closure requires a higher IVQ rate. In other words, the longer the closure period, the lower the IVQ. The main practical difficulty with IVQs is determining when a vessel has reached or exceeded the IVQ. A determination can be made based on an estimate of the vessel's year-to-date bigeye tuna catch or yellowfin and bigeye tuna combined. Near real-time estimates are made by on-board observers, which have difficulty in distinguishing small bigeye tuna apart from small yellowfin. In addition, observers get information from the vessel's crew in making catch estimates, and do not have the authority to stop a vessel from fishing. On the other hand, port sampling can be used to estimate the catch that a cannery receives; however, port samplers only cover small percentage of the fleet at present. The analysis indicated that there is a handful of vessels that are accounting for most of the overage of the bigeye tuna catch above the IVQ rate (Figure 18).





**Figure 18: Bigeye Individual Vessel Quotas analyzed for purse seine vessels operating in the EPO**

**Discussion Points:**

- Recognition that further IATTC consideration on catch limits will involve, for example, how to make a vessel stop fishing on FADs after it exceeds its IVQ, allowing them to fish in other areas of the convention area, and what to do with the other vessels that typically do not fish on FADs, but may opportunistically fish on a floating object.
- General agreement that accurate species identification is key in the implementation of catch limit options.
  - species identification between a few individual fish is not difficult, but what is challenging is estimating species composition when it is coming on-board in 10 or 20 ton brails at a time.
  - The WCPFC observer grab samples involve a few individual fish sampled per brail, but non-biased sampling with this method is an issue.
  - The other method, which is believed to be more reliable, is called a spill sample, which take less frequent but larger samples that dumped in sampling bin.
  - Future development of video image analysis technology has the potential to address the species identification issue.
- Recognition that transshipping catch adds delays in a vessel receiving cannery sizing summaries, so an IVQ program would need to overcome the time lag between fish unloading and cannery sizing summaries.
- There was general interest to investigate what the 20 boats are doing differently that result in considerably more bigeye tuna catch than the other boats, e.g. net depth.
  - The IATTC will be investigating net depth in 2016.
- A view were expressed that IVQs do not have to be tracked in real-time, and if there are overages then quotas get adjusted.

- Views were also shared that advances in electronic logbook reporting could support the implementation of IVQs.
- Acknowledgement that if an IVQ system was implemented, fishermen themselves would likely figure out how to avoid bigeye tuna, especially if coupled with a market disincentive to land bigeye tuna.
- Views were also shared that IVQ programs are complicated and simple measures are preferred.

### **3.2.3. Shelton Harley- Bigeye Purse Seine Catch Patterns Across Vessels and Sets**

Shelton Harley presented information on how bigeye tuna purse seine catches are distributed in the WCPO. The key metrics identified were the percentage of FAD sets that catch bigeye tuna, the percentage of FAD sets that are dominated by bigeye tuna, and comparisons of the top catching purse seine vessels operating in the WCPO. The dataset for the analysis presented is based on “non-raised” data derived from fishermen’s total catch estimates and observer grab samples, but not from port sampling, VMS data, and other information like he described in his earlier presentation. The dataset used estimates bigeye tuna, yellowfin, and skipjack at the individual set level.

With respect to how bigeye tuna catches are concentrated among the purse seine fleet, the analyses showed that from 2010-2014, between 9 and 14 vessels are responsible for 25 percent of the bigeye tuna purse seine catch. The analysis determined the proportion of bigeye tuna caught on each set and plotted it against how much of the catch comes from those types of sets. For example, 28% of the total bigeye tuna catch comes from sets that have least 50 percent of bigeye tuna composition.

With regards to small versus large sets and bigeye tuna composition, the data do not indicate that small sets have a higher percentage of bigeye tuna. In analyzing examples of potential individual vessel limits, the amount of the individual bigeye tuna limits influences the percentage catch reduction but also the number of the vessels effected. For example, an individual limit of 200 mt would have a 42 % reduction on the bigeye tuna catch and affect 31% of the fleet, whereas a limit of 1,000 mt would reduce bigeye tuna catches by 5% and affect 2 percent of the fleet.

The analysis also investigated the top ten percent of vessels that catch bigeye tuna. Over the four year period, 27 unique vessels had been in the top ten at least once, as opposed to the remaining 237 vessels. For these 27 vessels, bigeye tuna represents 12 percent of their total annual catch, whereas bigeye tuna comprise 4 percent of the catch for the other vessels. These top bigeye tuna-catching vessels also have a higher reliance on FAD sets, 60 % vs 42 % for the other vessels, and a higher percentage of FAD sets with more than 50% bigeye tuna in the catch than the other vessels, 9% vs 3% respectively (Figure 19). The bottom line is that these 27 vessels rely more on FADs, and when they use FADs, they catch bigeye tuna in higher per set percentages in comparison to the other vessels. The question then is, what are the factors driving these apparent differences, such as fishing location, net depth, or other considerations.

Criteria	Bigeye catching vessels	
	top	rest
Average annual number of vessels	27	237
Average annual tuna catch	119,719	702,227
Average annual bigeye catch	14,484	30,131
Bigeye proportion of total tuna	0.12	0.04
Proportion effort on FADs	0.60	0.43
Proportion FAD sets with bigeye	0.62	0.42
Proportion FAD sets with >50% bigeye	0.09	0.03
Proportion of bigeye from bigeye dominated sets	0.34	0.21
Proportion of tuna from bigeye dominated sets	0.09	0.03

**Figure 19: Comparison of the Top Ten Percent of WCPO Purse Seine Vessels Catching Bigeye to the Remainder of the WCPO Fleet.**

Source: Shelton Harley

**Discussion Points:**

- It was generally agreed that further investigation is needed on determining why 27 vessels are catching approximately 50% of the WCPO purse seine bigeye catch, including a review of the economics of the 27 vessels.
- It was noted that the results highlighting the 27 vessels were surprising, but that the 27 vessels were likely operating in full compliance with the FAD closure and other measures.
- Some participants were surprised to that some purse seine vessels were catching more than 1000 mt of bigeye per year on an individual basis, which is likely linked to the skipper’s intention and on-board machinery that contributes to preference for setting on FADs rather than free-schools.

**3.2.4. Valerie Chan- Challenges and Opportunities in Developing an Individual Quota System for Bigeye Tuna in the WCPO: A case study of the US Purse Seine Fishery**

Valerie Chan, Fishery Policy Analyst (NOAA Fisheries), presented on challenges and opportunities in developing individual purse seine quotas in the WCPO using the US purse seine fishery as a model. Individual quotas are part of a system where there is an established Total Allowable Catch (TAC), which is then broken up into smaller amounts and distributed to eligible participants (e.g. individuals, communities, cooperatives etc.). The general thought is that participants can fish until their quota is reached. Quota systems are used globally and identified benefits include eliminating the “race to the fish” scenario as well as greater efficiency through reduced overcapitalization. Individual quotas may be non-transferable or transferable, depending on the design of the system. Individual quotas tend to result in less efficient fishers exiting the

fishery, which can lead to quota concentration within the remaining participants, which can have disadvantages.

To implement vessel limits, the first step would have to be the establishment of a TAC, whereby the WCPFC would have to decide whether the TAC would be divided among CMMs or gear types, as well as decide the formula to allocate the TAC. Historical effort or catch is often used, but considerations for SIDS development aspirations would also need to be considered. With respect to historical catch, for example, there have been different estimates of US purse seine bigeye tuna catch identified by the United States versus the SPC, so a clear methodology for determining historical catch would have agreed upon.

Implementing and monitoring individual quotas are a substantial challenge, with the identification of bigeye tuna already identified as major issue within workshop. Timely catch reporting and catch estimates are needed to track quotas and to prevent vessels from exceeding their limits. Advances in electronic reporting could address this issue.

While there are substantial challenges to implementing individual quotas, it does offer a potential mechanism to address bigeye tuna overfishing from the purse seine sector (Figure 20).

#### **Challenges**

- Setting the TAC
- Allocating the TAC between gear types and among CCMs
- Deriving accurate bigeye tuna catch estimates on a timely basis
- Monitoring and enforcing quota limits

#### **Opportunities**

- End overfishing on bigeye
- Limit catches on bigeye from purse seine vessels

### **Figure 20: Challenges and Opportunities with Individual Vessel Limits**

Source: Valerie Chan

#### **Discussion Points:**

- Views were expressed that an agreement on allocations of a TAC within the WCPFC would take years and be a difficult process.
  - Different allocations for the high seas and EEZs would have to be established, which could result in flag state vs coastal state tension over the distribution of rights.
- It was pointed out that an additional challenge to quotas on juvenile bycatch is that catch rates are strongly driven by recruitment trends, so a quota could be reached early in the year due to strong recruitment, when in fact that would be a time that the stock could withstand more pressure. The same could hold true on the other end, when recruitment is low, but the quotas are maintained and catches are impacting the stock to a greater degree.
  - Implementing a system that could have multiyear TACs or being able to account for overages and underages could address inter-annual variability.
  - IVQs offer the potential for transferability among pure seine and longline fisheries, serving to remove bigeye tuna overfishing while also addressing disproportionate burden issues.
- Views were provided that given the challenge of monitoring quotas and the variability among observer estimates and other estimates of purse seine bigeye tuna catch, IVQs would be much harder than developing a technical solution to avoid catching bigeye tuna.

## WCPO Purse Seine Bigeye Management Workshop Day 2

### 3.3. Gear Modifications and Other Technical Options

#### 3.3.1. Victor Restrepo and David Itano- ISSF Research

Victor Restrepo provided an overview of ISSF, which is non-governmental organization comprised of scientists, industry, and environmental organizations. This wide base of expertise is used to look at science-based initiatives to influence RFMO governance structure to directly tackle issues of ecosystem health such as mitigating bycatch.

David Itano provided a description of recently completed or ongoing ISSF research projects. As described earlier, acoustic selectively research is being conducted echosounder target strengths and filters for skipjack, bigeye tuna, and yellowfin. In addition, work is being done on comparing the main brands of echosounder buoys with respect to identifying tuna species. Research has been conducted using acoustic telemetry and sonic tags to determine vertical behavior and residency of tunas on FADs.

Information gathered indicates that skipjack and yellowfin occur together fairly closely with respect to depth during the day, whereas bigeye tuna occurred deeper but not much deeper. Other studies include investigation on the sensory abilities of tuna the ability to differentiate species based on response to light and sound. Research is also planned on looking at the difference in aggregation qualities of FADS based on their design with deep or shallow appendages, to investigate if deeper FAD appendages aggregate more bigeye tuna. There will be four research cruises on purse seine vessels in 2015 covering the Eastern Pacific, Atlantic Ocean, and WCPO.

Restrepo commented that their research is looking at ways to reduce the catches of bigeye tuna; however, not all bigeye tuna is bycatch, especially larger sizes of bigeye tuna. There has been some work on identifying an undesirable size threshold, for example fish at sizes less than 3.5 kilograms. If bigeye tuna at this size were avoided, bigeye tuna overfishing would be nearly eliminated and MSY would increase by 10 percent. This could shift the selectivity to large fish sizes and a way to get the fleets to target sizes that have both market and conservation value.

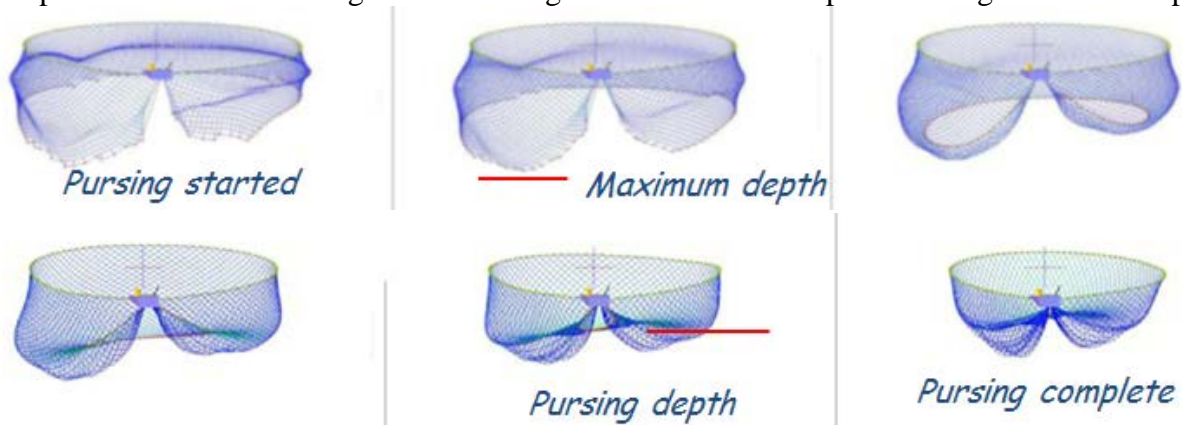
#### **Discussion Points:**

- With regards to minimum size limits, it was recognized that the establishment of catch minimize size measures require the ability address non-compliance.
  - ICCAT's minimum size limit was provided as an example whereby the minimum size requirement has been established for over 20 year but has lacked enforcement.
- With regards to research on vertical stratification of tunas, it was acknowledged that the thermocline depth in the WCPO (deeper) and EPO (shallower) plays a role in distribution of tuna species in the water column.
- Views were expressed that the current practice of making FAD sets just before dawn to yield the highest catch could be restricted if such a measure was proven effective with respect to bigeye conservation, , but more work needs to be done to explore this.

### 3.3.2. David Itano- Gear Modifications and Other Technical Options

David Itano presented on net depth as a potential gear modification. In the EPO, the most common net depth is about 190 meters, whereas a net depth 275 meters was common in the WCPO in years 2005-2009. Updated to 2014, information suggests that the most common net depth in the WCPO is now between 300 and 350 meters. Deeper nets are used in the WCPO due to the thermocline being deeper in the WCPO versus the EPO, as well as clearer water in the WCPO; thus, school fishing in the WCPO requires much deeper nets to maximize catch rates.

Itano described several diagrams of purse seine gear and operational aspects of the fishing gear being pursed, and noted that the actual fishing depth is considerably shallower than the rated net depth (i.e. pursing depth typically 56% of rated net depth; Figure 21). The type of purse seine netting, i.e. with or without knots, also makes a difference in how fast the gear sinks and has different pursing characteristics. The mesh size also matters in terms of depth of net strips, which is important when considering the monitoring and enforcement of purse seine gear and net depth.



**Figure 21: Schematic representation of pursing the net**  
Source: David Itano

Itano went on to describe several studies on the vertical behavior of tunas. When aggregated on a FAD in the WCPO, tunas uniformly show relatively shallow behavior, and generally staying above 100 meters during the day or night. During the early morning, pre-dawn period, skipjack, yellowfin, and bigeye tuna are found mixed within these shallow areas, which does not provide much opportunity to exclude bigeye tuna from the other species. Requiring purse seine gear to fish at 50 meters, for example, would be senseless because it would make the net impractical for school fishing. While some research suggests skipjack has a shallower swimming depth than yellowfin and bigeye tuna, the depth difference is not significant enough to reduce the catch of bigeye tuna through purse seine gear modifications. In addition, there are several issues that need to be considered when discussing the net depth such as: 1) measuring net depth and variations in strips, 2) different types of net material, 3) region specific thermocline depths, 4) successful school fishing requires a minimum net length and depth that is area specific, 5) purse seine vessels move between regions, and 6) monitoring and enforcement issues.

Wright asked Schaefer if there was any supplemental information that he would like to add. Schaefer agreed with Itano that the depth differences from the eastern to the western Pacific between skipjack and bigeye tuna when associated with FADs, are not great enough to consider net modification as a management measure, even though the depth differences are significantly different. He also mentioned that they have been exploring the concept of catching skipjack tuna as they move away from FADs, taking advantage of the dynamic movement of sub-schools when they aggregate on FADs. Unfortunately, the study was not able to capture any of the fast-moving skipjack schools as they moved off the FAD and it was concluded that this concept was also not a feasible solution.

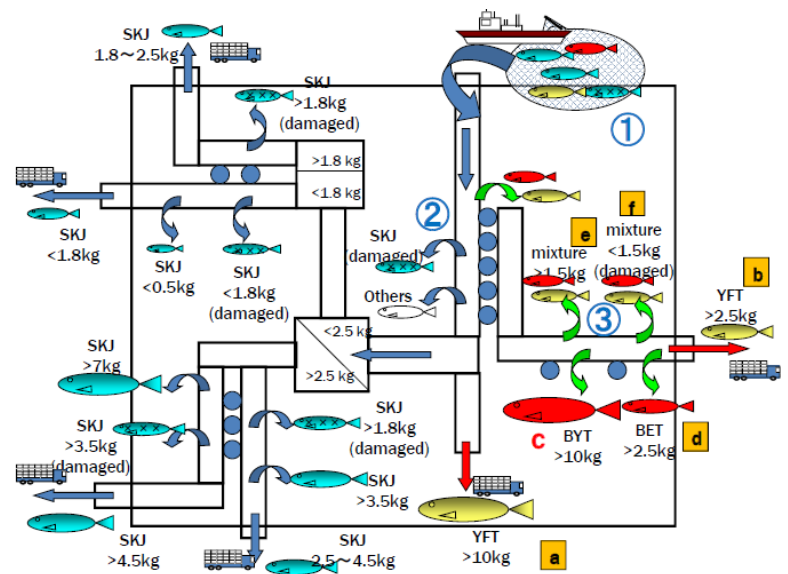
**Discussion Points:**

- Some Industry participants indicated that net modification may be a viable option if proven effective, but any changes would need to take into account that the same net is for both FAD and free-school fishing, which have operational characteristics.
- Views were provided that the time of set on a FAD is important and it is believed that non-compliance is occurring during the FAD closure, whereby sets are being made within 1 hour of local sunrise, but reported as school fishing.
  - It was expressed that one way to avoid this occurrence is to prohibit setting between sunset and 1 hour after local sunrise during the FAD closure months.
  - It was noted that there are other examples of measures that utilize local sunset/sunrise times and that nautical twilight calculators are accurate for compliance and monitoring purposes.

### 3.3.3. Yujiro Akatsuka- Gear Modification and Other Technical Options: how Japan has implemented bigeye tuna bycatch reductions

Yujiro Akatsuka, Assistant Director (JFA), presented on how Japan has implemented bigeye tuna mortality reduction measures. In 2009, Japan implemented a purse seine catch limit which was allowed under CMM 2008-01 as an alternative measure to the FAD closure. The measure required that the catch limit be held to 90% of 2001 or 2004 levels and required port monitoring for every trip per vessel, submitting landing data within 30 days of landing, and observer coverage. Japan chose the catch limit option because of the operational nature of Japanese purse seine vessels, market practice, and that Japan could provide the required data. The operation of Japan purse seine vessels are unique in that they depart Japanese ports, fish in PNA waters, then return to Japanese ports to offload – transshipping is not common practice. Based on the operational practice of vessels, the JFA can monitor all vessel unloading, which was approximately 245 trips.

The majority of Japan’s purse seine catch is processed and consumed in Japanese markets, such as for katsuobushi and sashimi. Catch is sorted and sized by the Fisheries Cooperative Association and then sold at auction (Figure 22). This market practice makes it possible to get species and size composition. In Thailand, for example, sorting and sizing is conducted at the canneries, but in Japan it is conducted at ports. Catch is sorted by size class and species; however, yellowfin and bigeye tuna are not distinguished below 2.5 kilograms. A formula is applied to estimate the species composition of the mixed catch.

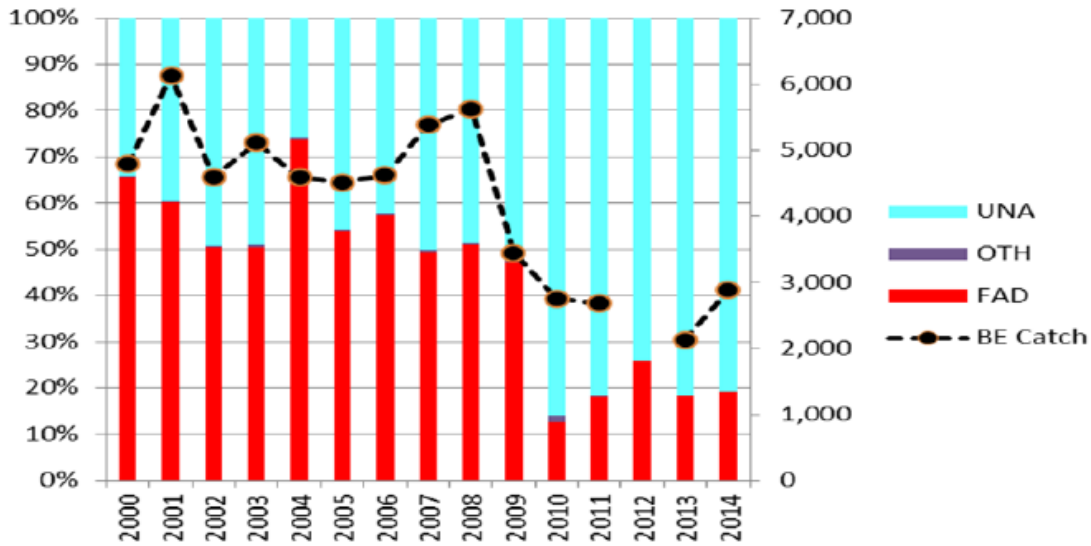


**Figure 22: Sorting and sizing process at Yaizu Port**  
Source: Yujiro Akatsuka

Submitted logbook data showed a 56% lower reported bigeye tuna catch than amount identified at the ports; however, observer coverage on board the vessel improved the vessel’s logbook report of bigeye tuna catch. The bigeye tuna catch limit that was applied was 5,971 tons. The port monitored bigeye tuna catch was estimated at 2,894 tons. The catch limit option was only available in 2009, and since that time Japanese vessels have been complying with FAD closure.

However, Japan’s purse seine bigeye tuna catches have remained below historical averages for two reasons: 1) fuel prices have forced vessels away from the eastern area of the WCPO, and 2) vessels have increased school-setting as less effort on FADs. The Japanese purse seine fleet has changed its operation patten from FAD depended to school-set dependent, which has reduced the catch of bigeye tuna. For example, the percentage of FAD sets was at 60 percent and now it is at around 20 percent, while the catch of bigeye tuna went from 5,000 mt to less than 3,000 mt (Figure 23).





**Figure 23: Japanese purse seine vessel fleet's percentage of FAD and unassociated effort and catch of bigeye**

Source: Yujiro Akatsuka

**Discussion Points:**

- It was acknowledged the Japanese port sampling system is a leading model in terms of producing accurate purse seine species composition data; however, even this model included the mixing all species in the <3.5 kg size range, which could be improved upon by species sorting at this small size class.

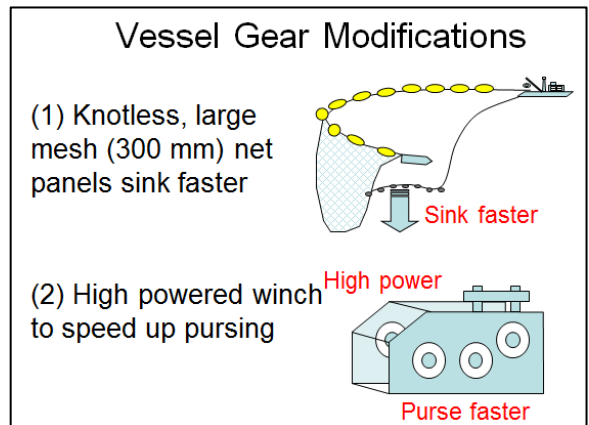
**3.3.4. Taro Kawamoto- A challenge to reduce bycatch of BE tuna by a Japanese tuna purse seiner**

Taro Kawamoto, Director (Kyokuyo Suisan Co., Ltd.) described a project to improve free school fishing efficiency on the F/V Makaba Maru No.8, a Japanese purse seine vessel that he characterized as “old and small.” Due to regulations restricting fishing capacity imposed by the Japan government, Japanese purse seine vessels are smaller than those in U.S., Taiwanese, and Korean fleets. As such, Japanese vessels have historically been dependent on FADs due to their small size and restricted fishing power.

Fishing on FADs does not require as much skill as does making school sets. In addition to skipper skill, net sinking speed and winch power also contributes to school setting success. It was identified that the key to increasing free school fishing efficiency in the Japanese fleet was increasing the net sinking time to decrease fish escape. Larger mesh nets with knotless net panels increase the net sinking speed and high power winches decrease pursuing time. The Wakaba Maru No. 8 modified its net from 28 sections of 240 millimeter mesh to 30 panels of 300 millimeter mesh, which increased the sinking rate of the net by 7%.

A high powered winch was also outfitted to the vessel that increased pursing speed by 1.5 times, reducing time pursing time from 45 minutes to 20 minutes (Figure 24).

The project found that F/V Wakaba Maru No.8's success on school sets doubled, the percentage of its FAD sets decreased by 60%, and its bigeye tuna catch decreased by 80% from the vessel's historic levels. Kawamoto concluded that to shift to more school sets requires to things: 1) skipper skill, and 2) adequate machinery and gear to enhance school set success. Lastly, he mentioned that the success of the project has encouraged other Japanese purse seine owners to modify their gear to improve free-school fishing efficiency, which has likely contributed to the reduction of Japanese purse seine bigeye tuna catch since 2010.



**Figure 24: Gear modifications made to the F/V Wakaba Maru No. 8 to improve school set fishing**

Source: Taro Kawamoto

#### **Discussion Points:**

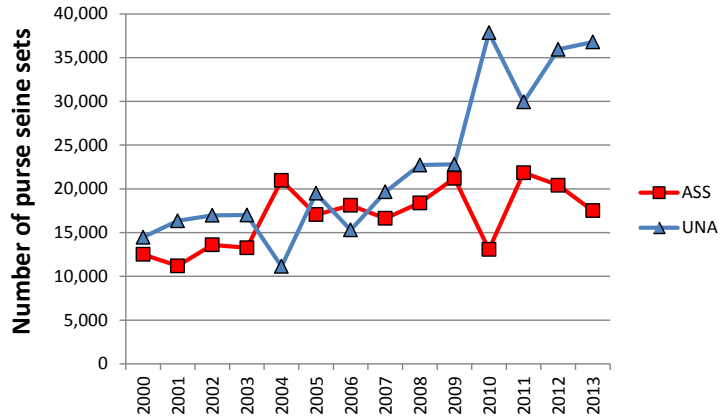
- There was general commendation for the efforts of Japanese vessels to reduce purse seine bigeye tuna catch through fishing more on free-schools, in spite of FAD fishing associated with lower costs and higher CPUE values.
- Concern was raised that more free-schools could negatively impact yellowfin; however it was noted that the SPC did an analysis on the impact of transferring effort to free schools that showed positive effects on yellowfin stock status and MSY type metrics.
- Some industry participants indicated that small bigeye tend to rise to the surface when the net is pursed and wonder if there could be an opportunity to release the small fish alive.

### 3.4 FAD-based Issues

#### 3.4.1. John Hampton- Effects of FAD-based Measures in the WCPO

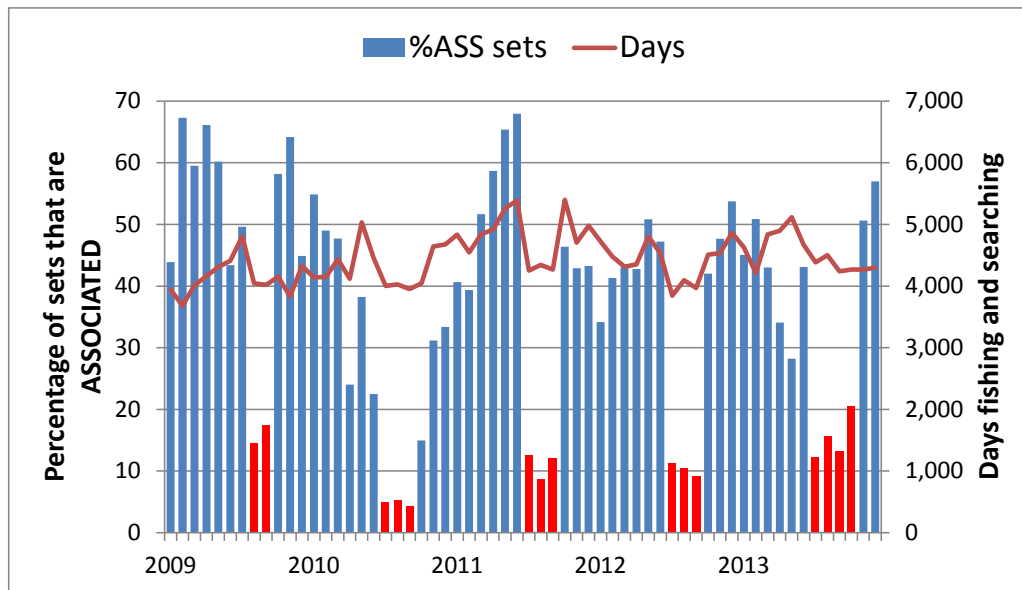
John Hampton presented on the effects of FAD measures implemented in the WCPO between 2009 and 2014. There has been an increase in the number of unassociated sets since 2009, with 2010 a particularly good year. Associated or FAD sets have relatively stable since 2009, thus it appears that the FAD closure has had an impact the potential number of FAD sets (Figure 25).

Generally, 40 to 60 percent of total annual purse seine effort is on FADs; however, during the seasonal FAD closure, this percentage drops to less than 20 percent. There is still some residual FAD effort during the FAD seasonal closure because the measure, for example, does not prohibit FAD fishing in archipelagic waters (Figure 26). Based on the number of fishing days, the purse seine fleet does appear to continue to operate during the FAD closure months.



**Figure 25: Annual WCPO purse seine associated or unassociated effort, 2000-2013**

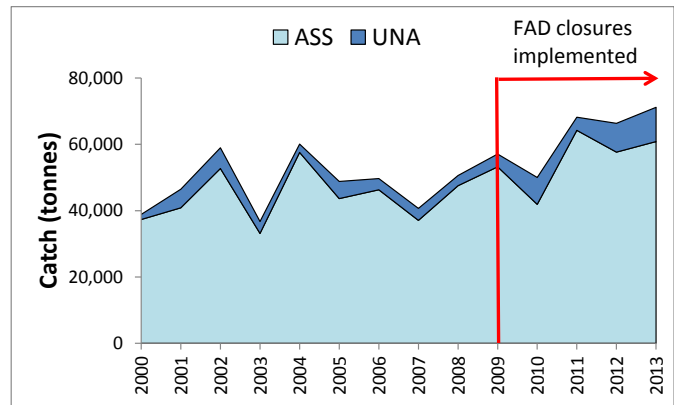
Source: John Hampton



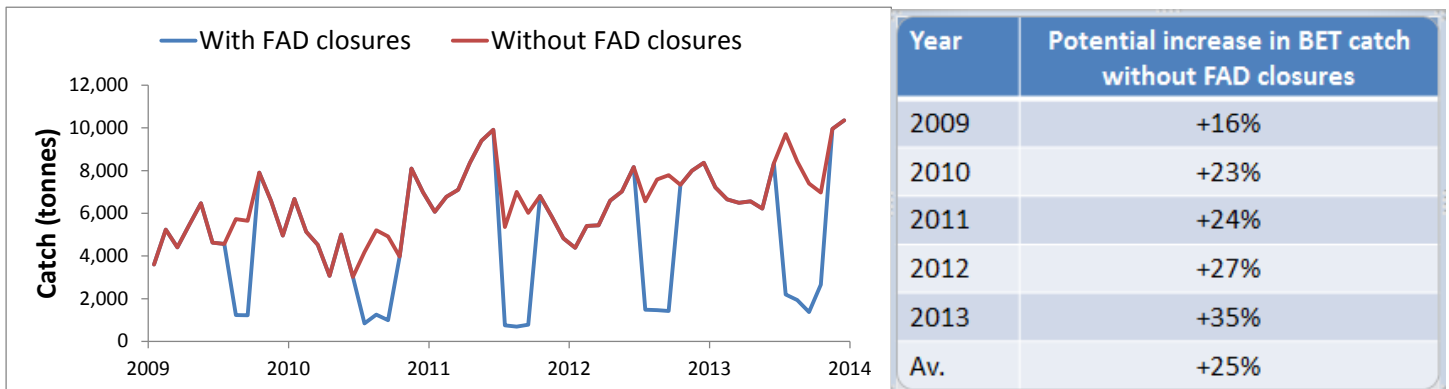
**Figure 26: WCPO purse seine fishing effort associated set percentage and number of purse seine fishing days**

Source: John Hampton

Since the implementation of the FAD closure, the catch of bigeye tuna by purse seine vessels has not decreased, and apart from 2010, the trend has increased (Figure 27). This has led to the opinion by some that that the FAD closures have not been effective. However, another way of looking at is to estimate what would have been the bigeye tuna catch in the absence of the FAD closure. From that perspective, it is estimated that without the FAD closure, purse seine bigeye tuna catches are estimated to be on average 25% higher (Figure 28).



**Figure 27: WCPO purse seine bigeye catches**  
Source: John Hampton



**Figure 28: Estimated Impact of WCPO FAD closure periods on purse seine bigeye catches**  
Source: John Hampton

**Discussion Points:**

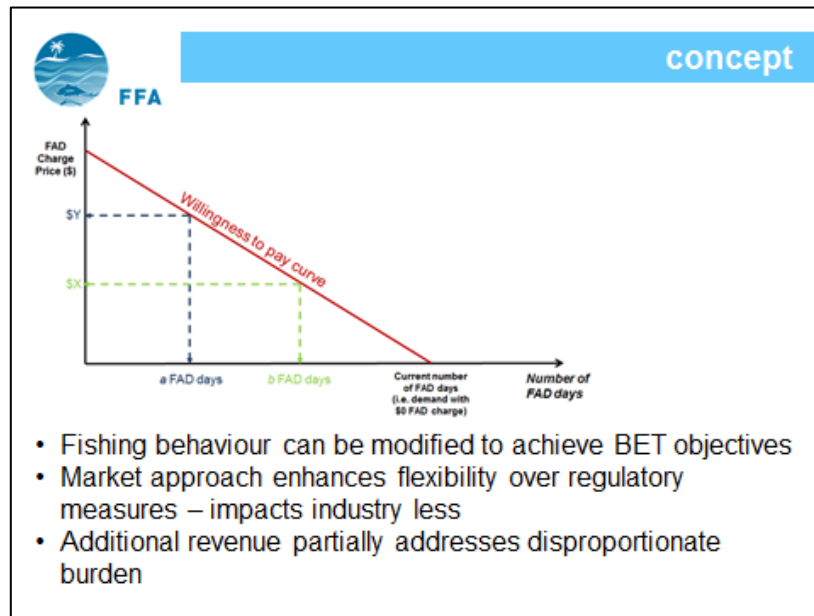
- It was highlighted that the annual number of associated sets in the WCPO have stayed the around same level, but the number of free-school sets has increased. Concern was raised with the accuracy of the logbook data with respect to recording the appropriate set type. It was noted that the SPC has cross-checked the logbook data with observer data so there is confidence in the data.
- Recognition was provided that the FAD effort during the closure periods would be closer to zero without the exemptions allowed to some fleets;
- It was identified that the existing WCPFC measure allows fleets to choose a 3 month FAD closure plus FAD set limit or take a 4 month FAD closure.
  - The various options a fleet can choose has added complexity the measure, and questions remain on whether the 3 month FAD closure plus FAD set limit is equivalent to a 4 month FAD closure in terms of impact to bigeye fishing mortality.
- It was recognized that FAD setting leading up to and following the FAD closure in an issue. In 2009, when the closure 2 months, there was a tapering off and gradual ramping up on the margins of the closure. From 2010 or 2011 onward, there has been a very solid and constant FAD setting leading up to and following

the closure, suggesting that the FADs are left in the water throughout the FAD closure and continue to fish. Fishery statistics confirm that FADs are left in the water to aggregate fish during the FAD closure as data show purse seine catches increases shortly after the FAD closure period ends.

- It was stated that the PNA is looking to conduct FAD registration and tracking which could address the ‘soaking’ of FADs during the closure period.
- It was recognized that the size of fish caught during the FAD closure period are much larger for all species, but particularly pronounced for yellowfin tuna, whereby the size of yellowfin tends to be much higher in unassociated sets.
- Some industry participants were of the view that there is a problem with compliance during the FAD closure. For example, it is not always obvious what is a FAD set and what is not a FAD set. It was stated that the compliance issue is one aspect that is likely not addressed when comparing the impact of the FAD closure vs a potential total closure.
- It was recognized that since the 2014 WCPFC TCC meeting, there are a number of flag states undertaking investigations of observer-reported violations of the FAD closure. There is an expectation that more observer data will be available for compliance monitoring this year, which will lead to an improved understanding of effectiveness and compliance of the measure.
  - It was further recognized that that the effectiveness of the measure would be strengthened with improved compliance monitoring and sanctions were available in the case of non-compliance.

### **3.2.4 Wez Norris- Controlling and Reducing FAD Usage Through Pricing**

Wez Norris, Deputy Director General (Pacific Islands Forum Fisheries Agency), presented on the potential for controlling and reducing FAD usage through pricing mechanisms. In addition to regulatory measures such as the FAD closure, there are other incentive or disincentive options that involve economic decisions and a willingness to pay. It is known that FAD fishing results in higher catch rates, more operational certainty, and generates extra profit versus school fishing, which has associated costs from searching (e.g. helicopter costs). This is can be viewed as a willingness to pay relationship (Figure 29).



**Figure 29: FAD pricing concept and willingness to pay relationship**

Source: Wez Norris

Currently, there are no fees from fishing on FADs. The theory is that if you increase the cost of conducting a FAD set, then there might be a decrease in the willingness to pay, and if there is even a higher price on FAD sets, then the number of FAD sets would be reduced. If the relationship between number of FAD sets and FAD charge price can be proven, it can be used to influence fishing behavior, which could result in bigeye tuna conservation. In addition, the revenue generated from the pricing mechanism could be used to address the disproportionate burden issue.

The PNA is looking to implement a FAD-charging mechanism consistent with the VDS. While this system would cover the bulk of the purse seine fishery, it would address only half of the bigeye tuna mortality. The WCPFC would need to agree to compatible measures for the high seas, reform of the longline fishery, and measures for the non-PNA EEZs (e.g. Philippines and Indonesia). Compatible measures do not mean identical, but rather to achieve the same objective, so there is no expectation that the WCPFC would have to develop a similar FAD pricing mechanism for the high seas or for non-PNA EEZs.

The biggest challenge to the FAD pricing mechanism is determining what price level to charge on FAD sets to influence behavior. Through the model used by the PNA to set benchmark VDS prices, it is believed that there is a 50% difference in the rent generated on FAD sets as opposed to free schools sets – approximately \$6,000 per day across the entire fishery. This estimate is highly variable across fleets, so it is not that simple; however, the point would be to tune the price of FAD sets according to the conservation objective, which for example, does involve considerations of the tradeoffs between the longline and purse seine fisheries. A few years ago, the SPC calculated that 11,314 FADs sets would remove 50% of bigeye tuna overfishing, which basically emulates 2010 conditions. There are currently around 15,000 FAD sets annually, so there are potentially 3,500 FAD sets that need to be removed.

One of the greatest potential benefits from the pricing mechanism is that it provides flexibility at the vessel level with respect to their operational decision making. Secondly, and with respect to the disproportionate burden issue, it would allow SIDS to capture a greater proportion of a vessel's lost profitability from fishing on free schools through the premium that would be charged for a FAD set.

Another aspect that the PNA is looking at is whether there needs to be a change to the WCPFC measure with respect to FAD set limits and to how the PNA establishes the FAD pricing mechanism under the VDS system (e.g. Party X has 3,500 free school days and 3,200 FAD days). The PNA is looking to implement a FAD-pricing mechanism in 2016, which will require the establishment of compatible measures by the WCPFC.

### **Discussion Points:**

- Concerns were raised with the PNA FAD pricing scheme such that it is an untested model and no guarantee that the WCPFC will agree to compatible measures.
  - It was acknowledged that given the uncertainty, there is not an expectation that the WCPFC would need to remove the FAD closure with the first year of implementation.
- With regards to the consideration of the fee level for a FAD set, it was stated that PNA has an economic model of vessel-by-vessel revenue and cost structures and that the FAD fee will be discussed by PNA Ministers at their June 2015 meeting.
  - It was noted that the FAD pricing scheme could serve as an alternative to a lengthy FAD closure so potential operational flexibility could be seen as a benefit to the purse seine industry.
- With respect to the notion of longline fishery reform, it was identified that the SIDS are not beneficiaries of bigeye conservation due to having minor interests in longline fishing. It was suggested that one method of reform is to provide SIDS more of a stake in the longline fishery, such as a longline VDS, which is a rights-based approach.
- Some industry participants were concerned that the timing of the FAD pricing mechanism corresponds with the current poor economic situation of the purse seine fishery with regards to fish prices, and that the added potential costs for FAD sets in addition to VDS prices could spell economic disaster for some fleets.
  - It was commented that moving to free-school fishing results in economic costs, and additional costs for FAD sets would serve as penalty and further economic loss. Given the current economic situation, vessels shifting to more free school sets should be rewarded through reduced VDS costs.
- It acknowledged that even though FAD set bigeye CPUE is not spatially uniform among PNA members, there would not be differential FAD pricing by EEZ as this could pit parties against each other.

### **3.5 Market-Based Initiatives**

#### **3.5.1 Susan Jackson- Bigeye Market Measures: Eastern Pacific, Atlantic, and Indian Oceans**

Susan Jackson, President (ISSF), presented information on bigeye tuna markets in the Eastern Pacific, Atlantic, and Indian Oceans. The three markets reviewed were: 1) round (whole) fish, 2) fish products, and 3) crew labor. With respect to round fish markets, in all three regions, there is typically one negotiated base price between the buyer and the vessel for skipjack, yellowfin, and bigeye tuna that weigh between 1.8-3.4 kg, regardless of species. For fish not in this size range, there are price differentials off that negotiated base price which are generally standard. The differentials depend on the species, but more so the size of the fish, where smaller fish yields less packable meat, and receives a subtraction to the base price. Larger fish yield more meat and receive an addition to the base price.

At processing facilities in the EPO, the price for yellowfin and bigeye tuna between 3.4 and 10 kg are the same, and greater than the skipjack price at that size. This is mostly due to the yield off the fish at that size than market preference. Yellowfin greater than 10 kg receive approximately double the price of bigeye tuna at that same size. Yellowfin has the premium price at large sizes, followed by bigeye tuna, which suggests that there is market demand for large yellowfin and bigeye tuna in the region.

For Atlantic and Indian Ocean fish shipped to Bangkok, there is no price difference between all three species at the 3.4 to 10 kg size. However, yellowfin at 10 kg and higher fetch 6 times the price of the bigeye tuna of the same size. This indicates that there is less demand for large bigeye tuna in Thailand markets as opposed to the EPO markets. If a vessel lands fish at Atlantic or Indian Ocean processors, there is sometimes a second negotiated price for large yellowfin (>10 kg) primarily due to the demand for yellowfin in Europe. However, the large bigeye tuna are still linked to the skipjack differential, where it is less than yellowfin, but receives a higher price than skipjack. This suggests that bigeye tuna are being processed in the region for tuna product, with less demand than in the EPO, but higher than in Thailand. If the large bigeye tuna are transshipped to Spain, it receives similar pricing—less than yellowfin, but higher than skipjack.

From a canned-product perspective, the bigger the bigeye tuna, the worse quality the product will be, resulting in a mushy, off-color greenish tint. In addition, large bigeye tuna are hard to process, reducing throughput. Some canneries in the Indian and Atlantic Oceans refuse large bigeye tuna, and if there is no choice but to buy the entire vessel's load, the large bigeye tuna will be sold in the local markets and not processed.

In the United States, the labeling for skipjack, yellowfin, and bigeye tuna are all “light meat” products, with no requirement to identify the species on the can's label. In Europe, bigeye tuna and yellowfin are labeled “atun claro,” with some companies labeling their products by species for their own traceability programs; however, bigeye tuna is not marketed, and some retailers are refusing to purchase products containing bigeye tuna.



As opposed to demand for bigeye tuna canned products, markets in Europe have developed for bigeye tuna steaks and loins, which is the reason for observed price differential for large bigeye tuna. This market developed as a result of processors either not accepting or offering a substantially reduced the price of bigeye tuna in Latin America. As bigeye tuna were still being caught, vessels owners went out on their own to develop the European bigeye tuna loin market. This is important to recognize that market incentives need to consider the whole picture, whereas one market solution can lead to other issues if they are not interrelated.

With regard to crew payments, these markets are the least transparent. Market incentives are only effective if they change fishing behavior, and if incentives are not transferred from processor to vessel owner, and then vessel owner to crew, it is likely that the market measures will not be successful.

#### **Discussion Points:**

- There was general acknowledgement on the need for market-based incentives to reach the crew in order for such measures to be effective.
- Concern was voiced over the current lack of price premiums for FAD-free fish, whereas in the past, the premium existed.
- It was acknowledge that some companies in the US are starting to label their products with species names, but that there are not requirements to do so, and it is unknown if the market is rewarding this practice.
- A view was shared that the WCPO full catch retention requirement was supposed work as a disincentive to catching small bigeye tuna; but the incentive is not there because there are no price differentials between small bigeye and skipjack.

#### **3.5.2 Kevin Bixler- Asia Pacific Bigeye Markets**

Kevin Bixler, Vice President (Chicken of the Sea), presented information related to bigeye tuna markets in Asia with particular focus on the Thailand processing industry and specifically Thai Union. Ninety percent of the raw tuna material received at Thai Union canneries comes from the WCPO. A major issue is the discrepancy in the amount of bigeye tuna declared on import documents and the amount they actually receive at their Bangkok canneries. In 2010, for example, 600 tons of bigeye tuna was declared, but they actually received 7,000 tons of purse seine-caught bigeye tuna. Reasons for the discrepancy are attributable to skipjack and bigeye tuna receiving the same price at sizes below 3.5 kg as well as vessel operations and the need to get the fish frozen quickly for HACCP considerations, which does not leave much time for sorting. Another important consideration is that the percentage of bigeye tuna received has remained stable at 2.5 to 3 percent, even after the implementation of the purse seine FAD closure in the WCPO.

During the first years of the WCPO FAD closure and the growing concern over bigeye tuna, it appears that fishermen were intentionally underreporting their bigeye tuna catch over fears that more FAD restrictions were looming and potential impacts that would have their total catch. However, it turns out that the FAD closure has had less impact on vessel operations and total catch, and since there appears to be better logbook reporting of bigeye tuna, which could also be attributed to 100% observer coverage. Recently, there were reports of more bigeye tuna coming

into Thailand, but it is just a reflection of more accurate reporting, not necessarily more bigeye tuna imports.

There are two markets that specifically request canned bigeye tuna, Japan and Chile. The remainder of markets can accept bigeye tuna as a substitute for skipjack, although a few can accept bigeye tuna as a substitute for yellowfin (not including the United States). Documentation requirements for importing bigeye tuna products are also becoming more difficult with respect to species identification and traceability. Europe and the Middle East markets require species identification on canned products. The main can tuna markets for bigeye tuna are the US and Africa where skipjack, yellowfin, and bigeye tuna can be blended. In the U.S., even bonito and frigate tuna can be labeled as “light meat.” Bigeye is not a good product for canning, it has a different texture, color, and taste that customers can identify.

#### **Discussion Points:**

- With regards to species identification, it was recognized that it is difficult for captains to distinguish if the bigeye percentage of the set was 2 percent or 8 %.
  - As a result of improved on-board and port sampling, it is now generally understood that logbooks have been underestimating bigeye tuna.
  - Logbook reports of bigeye tuna catch appear to be more accurate the further east the fishing is due to bigeye tuna comprising a higher percentage of the catch.
- It was recognized that canneries also have accuracy issues with statistical reporting small bigeye tuna is often unsorted and mixed with small skipjack and yellowfin.
  - It was reported that historically this has been the case, but in recent years there are more incentives for canneries to segregate species at small sizes.
  - The SPC with assistance from ISSF, will soon initiate a project to fully document the cannery sorting processes to better understand the utility of cannery statistics.
- A view was expressed that the reason there has not been a change in the percentage of bigeye tuna coming into Thailand is because the purse seine catch of bigeye tuna in the WCPO has been increasing, which have served to keep the percentage stable over time.
- It was confirmed that some purse seine vessels are conducting ultralow freezing (-60 degrees Celsius) of large yellowfin and bigeye tuna Japan sashimi markets.
- It was acknowledged that due weak market demands for blended bigeye products, there appears to be a growing amount bigeye tuna loins and raw material in cold storage in China and Thailand, and so as to get rid of the fish, markets are being developed for this bigeye.
- A view was reiterated that there appears to be potential to release small bigeye tuna alive that swim to surface of the school in the net, but questioned if this practice would be in violation of the full catch retention requirement.
  - It was clarified that such releases would be dependent on national law implementing the full catch retention policy, but the WCPFC measure allows for the release of fish prior to 50% of pursuing operation.

#### **3.5.4. Jim Humphries- Eco-labels and Other Market Driven Incentives**

Jim Humphries presented on the role of eco-labels such as Marine Stewardship Council (MSC) certification within bigeye tuna markets. The MSC program for sustainable fisheries started in 1997 and is based on three main elements: 1) are the fish stocks healthy, 2) what is the impact of the fishery on the ecosystem, and 3) is there an effective fisheries management system in place. The MSC has voluntary certification program that is designed to draw in consumers and businesses and to affect change from within the market. Currently, there are 350 fisheries with MSC certification, which make up 10 % of the global catch. Of the 350 certified fisheries, 19 are tuna fisheries, including the PNA skipjack fishery.

The impacts of MSC certification generally fall into three categories: environmental, economic, and social. Positive economic results are not promised, but for those fisheries are the first in their category typically see the most positive returns initially, which can drop off as others with similar product obtain certification. Through the certification process, MSC looks to provide incentives to fisheries and companies to provide a return on their efforts. Within the MSC system, they have seen large-scale business commitments from some of the largest retailers in the world such as Costco and Walmart, and a new sector that is opening up is the international hotel group (e.g. Hilton).

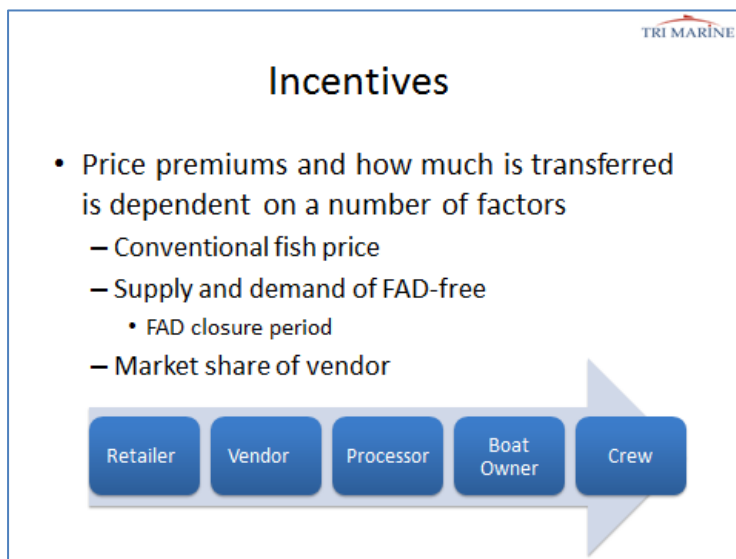
With regards to bigeye tuna, there are two opportunities. One is the sushi/sashimi market, where the MSC program is growing and seeing more interest in Japan, and is already established in the United States. The other opportunity is in canned tuna markets that include bigeye tuna as essentially a bycatch species. Part of the MSC program is to conduct audits on fisheries that includes target and non-target catch and bycatch. As the bigeye tuna bycatch issue in the WCPO grows, there will be more pressure and leverage to impact the situation.

### **3.5.5. Matt Owens- Vessel Incentives for Supplying FAD-free Fish**

Matt Owens, Director of Sustainability (Tri Marine), presented information on vessel incentives for supplying FAD-free fish. FAD-free fish has become broadly recognized as an environmentally responsible alternative to FAD caught light meat canned tuna. He described Tri Marine's FAD-free chain of custody protocols and standards from fishing vessels to retail markets.

Seafood rating programs and smear campaigns against retail companies that sell non-FAD free tuna are increasingly influencing company purchasing. FAD-free fish requires traceability and auditable procedures throughout the supply chain, from vessel to retailer, which requires costs that could be passed on to the consumer. However, how much of the price premium reaches the boatowner and crew is not consistent and depends on a number of factors.

When the price of skipjack is high, payments to crew for FAD-free fish are more common, but when the price of skipjack is low due to oversupply, the boatowner may not transfer payment premiums to crew in order to cover other costs. When vessel operators and crew do not receive any payment incentives from the owner, they are less likely to follow FAD-free protocols. In addition, the FAD closure distorts the FAD-free market due to a temporary supply spike, which can lower the price for FAD-free fish, resulting less of the premium transferred to the crew (Figure 30).



**Figure 30: Factors associated with FAD-free product incentives and transfer from retailer to crew**

In order for FAD-free market solutions to be effective in conserving bigeye tuna, the demand for FAD-free products needs to increase, with significant premiums passed down the supply chain in a consistent manner. While the market seems to be heading in that direction, challenges remain in the near term. One approach to help address the transition is the subsidizing of FAD-free sets by conservation groups, which is currently under development.

### **Discussion Points:**

- It was acknowledged that typically skippers get higher share percentages if fishing on free schools, whereas for the crew, they get paid the same whether if fishing free-schools on FADs.
  - It was noted that with respect to FAD free fish and chain of custody standards, it is the fishing master's burden to find the school fish, and the chief engineer's burden to ensure that the fish are properly separated, loaded and unloaded to meet traceability standards.
- With regard to market premiums for FAD free products, it was identified that there is not set formula, but the retail price is at least 20 percent for FAD free over conventional products.
- It was questioned why there was little to no premium paid by processors for FAD-free catch this year, as opposed to a premium of 7 to 8 % last year.
  - The supply and demand function was acknowledged and further that the seasonal FAD closure in the WCPO plays a role. Given the size of the fishery, it is fairly easy to flood the market with FAD free fish.
  - It was recognized that the price of the FAD-free premium is typically requested by the vendor with the product asking the retailer to pay for the premium.
- It was acknowledged that eco-labeling does not ensure price premiums, but does allow for market diversification and other related opportunities.
- With respect to chain of custody documentation for FAD-free fish, it was suggested that the WCPFC observer program could replicate protocols conducted in the IATTC for the dolphin safe program, where the observer documents fish by well number. The

- observer form would be part of the observer record that could be accessed in regards to audits.
- A view was expressed concerning the market competition between FAD free and FAD caught fish, such that it is the same species that go into the can, not like the difference between organic and non-organic which can include different ingredients.
    - It was stated that during the FAD-closure, all the vessels are FAD-free, but this does not allow them to get eco-certification.
  - A view was expressed that the FAD-free product market will grow based on consumer demand.

### **3.6 Considerations of Other Options and Issues**

Drew Wright explained that this section of the agenda was to explore ideas that were either touched briefly or to consider additional options that were not discussed.

#### **Discussion Points:**

- A view was shared there are significant differences in the estimation of purse seine bigeye tuna catch, with estimates from different sources including the SPC, national governments, and canneries. It was suggested that there needs to be consistent methodologies of estimating bigeye tuna catch that are compatible and that generate information that feed into the stock assessment.
- A view was provided that there is a need for the identification for voluntary contributions from industry and national governments of Distant Water Fishing Nations to meet bigeye tuna conservation objectives, as well as a need to address the disproportionate burden issue
- It was acknowledged that port sampling was relied upon more historically and when more of the catch went to on-shore facilities instead of being transshipped. With the development of transshipping, it is logistically difficult to do a statistically sound port sampling program when the practice is to move fish around on-board. If the FAD-free chain of custody requirements result in more FAD-free vs FAD catch being stored separately on vessels, port sampling would be enhanced from knowing FAD-free or FAD caught fish, but catch location would not be provided and knowing where and when the fish was caught is important.
- It was recognized that the catch of yellowfin and bigeye tuna by artisanal fleets in the Philippines and Indonesia are not insignificant and they appear to fluctuate substantially. Data collection challenges were acknowledged for artisanal fisheries in Indonesia, Philippines, and Vietnam, but that a substantial work has gone into improving the situation. The problem is not species identification, but inadequate sampling coverage coupled with a lack of statistical procedures to produce reliable catch estimates.
- The need for compatible measures between the WCPFC and IATTC was identified with regard to bigeye connectivity in the central equatorial region of the Pacific.

- A view was expressed in regards to the small number of vessels that are taking a significant percent of the total bigeye catch, there needs to be detailed examination of the observer records to potentially identify the reasons for the high levels of bigeye tuna catch on those vessels. The information gained could be used to fast track and focus research studies to find a practical technological solution to reduce purse seine bigeye catches.
- It was suggested that more research be conducted on the influence of light stimuli on FAD sets. Japanese researchers have found that bigeye tuna are attracted to lights and swim up higher in the water column, and the pre-dawn set issue is that they make sets then so the fish do not see the net.
- It was acknowledged that studies in the EPO did not determine an ability track skipjack when they leave the FAD; however, it is important to understand that the skipjack do move off the FAD, because 300-400 tons of skipjack are not feeding off the FAD, but move off the FAD to feed.
- It was recognized that the skipjack that move off the FAD are sub-schools, which indicate that the tuna aggregations at drifting FADs are very dynamic. Data from archival tagging studies suggests that sub-schools have residency times from a few days to a couple weeks, which is the same for bigeye tuna and yellowfin. Skipjack commonly move away from the FADs in the late afternoon, even being off the FAD at night; however, the highest biomass for all three species on FADs occur just before dawn, which is why pre-dawn sets are made.
- It was recognized that it is important understand the fates of deployed FADs, how many are there, how long do they last, and where do they end up. The IATTC has initiated a FAD marking and tracking system.
- A view was provided that although bigeye is considered a pan-Pacific stock, there are two assessments that utilize different methodologies and assumptions that produce different results. It was suggested that coherent management strategy evaluations be developed between the WCPFC and IATTC.
- A view was expressed that because there are cross-cutting issues (e.g. capacity management) that involve more than just the WCPO management, there should be a revamped Kobe tuna-RFMO forum where RFMOs identify effective management measures that could have broader application.
- It was acknowledge that there is a there is a pro-active industry agreement of Spanish vessels owners that operate in the Indian Ocean to cap their FAD deployments at 550 per year. Although there is not a skipjack resource problem in the Indian Ocean, it does see the highest concentration of FADs per square mile.
- The estimated average number of FADs deployed per vessel was discussed. It appears there as wide range within the fleet with Korean vessels recognized as deploying 60

FADs vessel to Spanish vessels that deploy 500 FADs per vessel. Generally, it assumed the average amount of FADs per vessel operating in the WCPO is between 150 and 300 (apprx. 45,000 – 90,000 FADs).

- A view was expressed that it should not matter how many FADs per vessel are deployed and that it depends on the size of the vessel.
  - A countering view was expressed suggesting that there is not a relationship between the size of and the number of FADs deployed.
  - Another view was provided that the number of FADs per vessel is an important metric monitor because each instrumented FAD equipped with an echosounder provides the captain a choice and an advantage over a competitor with fewer Fads in the water.
  - It was noted that the use of FADs instrumented with echosounders are believed to have reduced the number of no-set days and reduced the number of no-catch days, while providing opportunities for large-tonnage sets every day.
  - It was acknowledged that tuna aggregations on FADs are not even. For example, if there are 10 FADs in area, there is not ten tons under each FAD, but likely one with 80 tons and the others empty.
- It was recognized that based on IATTC observer information, there were approximately 14,000 FADs deployed in the EPO in 2013.
  - It was generally agreed that there needs to be more information collected FADs in the WCPO. For example, how many are out there, what are the dynamics of tuna on FADs, and how such information could help support stock assessments.
    - Some industry participants were of the view that managing FADs like any other fish gear could be accepted, but that any related measure must be adopted on a scientific basis.
    - A view was expressed that there is likely little scientific benefit from tracking FADs in real-time.
    - It was recognized that two scenarios related to FAD tracking that could transform the scientific understanding of the situation.
      - One scenario is that use of echosounder buoys has resulted in more bigeye tuna being caught because bigeye tuna, which has a swim bladder as opposed to skipjack, reflects a stronger sonar signal. A vessel operator if given options of several nearby FADS will select the FAD with the largest looking biomass; thus, the use of echosounder buoys may be inadvertently increasing bigeye catches.
      - The other scenario is what if FADS are working to split schools into smaller aggregations, such that more FADS means smaller schools. This would affect catch rates and the potential to suggest the stock condition is getting worse as catch rates fall, whereas the stock may just be more distributed in FAD aggregations.
    - It was noted that the collection of information on FADs has the potential to transform the scientific evaluation of stocks, and in particular, if the acoustic information generated from instrumented FADs was available for scientific purposes.

- It was noted that there is an IOTC measure that requires fleets report their FAD activity per quarter. In addition, there are requirements as part a recent FAD management plan to identify FADs individually and report all sets deployed and retrieved per trip.
- A view was expressed that the development of a new WCPFC conservation and management measure needs to consider capacity issues and the impact of exemptions.
- A view was provided that WCPFC measures encourage voluntary reductions in bigeye tuna fishing mortality, with examples by some fleets making great strides, while there are other fleets that do not make an effort to reduce their dependency on FADs.
  - It was further expressed that industry needs to take the first step, because passing on that burden to SIDS presents a very difficult economic situation.
- It was acknowledged that the detailed technical discussions that have occurred at the workshop are not practical for regular sessions of the WCPFC.
- There was encouragement made for more collaboration on these issues prior to the December 2015 WCPFC.



## **WCPO Purse Seine Bigeye Management Workshop Day 3**

### **4. Workshop Recommendations and Outcomes**

#### **4.1. Workshop Breakouts and Group Reports**

Workshop participants broke into five groups for further evaluation of management options that incorporated information discussed over previous two days. Each group filled in an evaluation table with the major findings reported out to the plenary.

##### **4.1.1. Spatial-temporal measures**

With respect to bigeye tuna hotspots, the small group acknowledged that there are different ways to identify closures, e.g. based on high bigeye tuna proportion, high CPUE, or high catch. The closure of areas with high total catch in the Western Pacific would reduce skipjack catches significantly. Disproportionate burden issues would apply if the closure was in EEZ of Pacific Island countries, with discontent coming from Distant Water Fishing Nations if high seas areas are closed. Based on these realities, industry participants on the group indicated that area closures are not a promising solution to the bigeye tuna problem.

On the other hand, industry participants in the small group felt that a total seasonal closure would be more effective for bigeye tuna conservation in the short term; however, the potential contribution depends on the length of closure. The group found that an in-depth bio-economic analysis is needed on potential total closure options including potential costs and benefits. One potential benefit mentioned is that right now the price of tuna is very low. A seasonal total closure could increase tuna prices if it reduces supply. Some WCPFC members who have been opposed to a seasonal closure in the past may change their mind if an analyses show positive economic benefits. Total closure is a short-term solution, whereas the long term solution is to find technical ways to reduce bigeye tuna catch while maintaining the catch of skipjack.

Other challenges to a total closure include when to place it in the year. The purse seine fishery seasonally moves west to east, so effects could vary on fleets depending on the timing the closure is in effect. Following the IATTC model, two closure periods could be established. A total closure that will reduce bigeye tuna overfishing by 50% would likely be quite long, so a shorter closure would need to be accompanied with additional measures. Lastly, a seasonal total closure with no exemptions was viewed as more equitable for all large-scale purse seine vessels operating in the WCPO.

<b>Temporal - Spatial Options</b>	<b>Potential Contribution to Reducing BET Fishing Mortality</b>	<b>Challenges (costs)</b>	<b>Opportunities (benefits)</b>
<b>Seasonal Total Closure</b>	<p>It depends on:</p> <ul style="list-style-type: none"> <li>- Length of closure</li> <li>- Any exemptions</li> <li>- Whether FADs need to be removed from the water before the closure</li> <li>- Whether total annual fishing effort is effectively reduced or not</li> <li>- Whether fishing behavior is changed or not so that fishers do not increase the number of FAD sets outside the closure</li> </ul>	<ul style="list-style-type: none"> <li>• May be difficult for some members to support, although industry participants felt that this may be changing. There is a need for bioeconomic modelling to better understand the benefits and costs of different closures to members, fishing fleets and processors. It was mentioned that the necessary data are already available (at SPC and elsewhere) and it was recommended that such a study be conducted.</li> <li>• May reduces catches of skipjack and yellowfin</li> <li>• When in the year to set a closure may be challenging. Having two closures that vessels can choose from (like in the EPO) may be easier for reaching agreement</li> <li>• Fishing effort could be displaced to the EPO during the closure, eroding potential benefits since BET catches are high in the EPO. An effective closure needs coordination between IATTC and WCPFC.</li> <li>• A total closure is not a silver bullet. It likely needs to be applied in combination with other measures in order to reduce BET overfishing substantially</li> </ul>	<ul style="list-style-type: none"> <li>• Generally seen by industry participants as the best option to reduce bigeye overfishing in the short term (technical measures to not catch BET seen as a better long-term solution)</li> <li>• A total closure is seen as simpler, cheaper, easier to monitor and enforce than other measures such as limits on FAD sets or a FAD closure</li> <li>• A total closure for the entire large-scale purse seine fishery is seen as [equitable][non-discriminatory]</li> <li>• Reduce oversupply and support good ex-vessel prices (to be confirmed by bioeconomic analyses)</li> <li>• May not affect SIDS access revenue because of high demand for VDS days combined with increasing number of vessels (to be confirmed by bioeconomic analyses)</li> <li>• Helps reduce fishing pressure on YFT and SKJ as well as other components of ecosystem</li> </ul>
<b>Temporal - Spatial Options</b>	<b>Potential Contribution to Reducing BET Fishing Mortality</b>	<b>Challenges (costs)</b>	<b>Opportunities (benefits)</b>
<b>Area closures (hot spots)</b>	<p>It depends on:</p> <ul style="list-style-type: none"> <li>- How the hot spot is identified (high BET catches, high BET CPUE, high BET % in total tuna catch)</li> </ul>	<ul style="list-style-type: none"> <li>• Generally seen by industry as not a very good option to reduce BET overfishing substantially without affecting catches of skipjack</li> <li>• Almost any hot-spot closures would involve EEZs which would cause disproportionate burden on different SIDs, depending on the objective (high BET catches towards west; higher BET CPUE towards central). Agreement from all stakeholders may be difficult</li> <li>• May not result in a reduction of BET catch but rather a redistribution</li> </ul>	<ul style="list-style-type: none"> <li>• Easy to enforce for high seas, but in zone monitoring by Flag state might need improvement</li> <li>• Low costs (?)</li> <li>• Area closures may have benefits but dependent on scale and location</li> </ul>

### **Discussion Points:**

- It was recognized that a seasonal total closure would have to consider the displacement of fishing effort, such as movement of vessels to the EPO during the WCPO closure, such that a WCPO total closure would need to be coordinated with the IATTC.
  
- With regards to bioeconomic modeling, it was recognized that an important aspect would involve price elasticity and whether or not a total closure could increase the price of skipjack, while also contributing to bigeye tuna sustainability.
  - It acknowledged that Bangkok price elasticity information is available, but similar data is lacking from the EPO.
  - It was suggested that the price of fish and value of the fishery would be important information, but that the evaluation of vessel profits or nonprofits would not be necessary.
  - Another important element would be to evaluate the potential loss of access revenue to Pacific Island countries.
  - It was added that bioeconomic modeling can be used to estimate costs and benefits, but evaluating outcomes with economic impact multipliers also lends to estimating impact on employment and income.
  
- It was noted that the effectiveness of a seasonal closure is uncertain if no reduction in effort is observed, but rather effort is spread out throughout the year due to increased number of vessels and the excess capacity is able to fish the available vessel days.
  
- It was stated that understanding what happens outside of the total closure period is critical, because if effort is not reduced, then the measure may have merit for skipjack market supply, but may not be effective for bigeye tuna conservation.
  - A view was expressed that it would be problematic if a total closure means PNA members would need to sell fewer days.

#### **4.1.2. Catch Limit Options**

The small group noted that there are a number of general considerations that apply to catch limit options such as: 1) the multispecies nature of the fishery and the potential for reducing skipjack catches from bigeye tuna conservation, 2) the complexities involved in allocating limits within the WCPFC and then further to the vessel level by CCMs, 3) the need for in-season monitoring of limits, 4) issues associated with deriving bigeye tuna catch estimates, and 5) various implementation and administrative issues.

Options reviewed were a) “global” purse seine TAC, b) flag-based TACs, c) Individual Vessel Quotas, and d) zone-based limits. A global TAC would be simple to establish, but it is blunt tool, and would likely result in a race to the fish scenario. Flag-based limits could be difficult to agree upon based on how they were allocated by the WCPFC. In addition, flag-based limits could also be viewed as undermining the PNA Vessel Day Scheme. This option, however, could prevent the potential race to fish that would occur under a global TAC option.

Individual vessel limits would require substantial administration at the national level and less on the commission level, but advances in electronic reporting could help monitoring vessel catches and limits. IVQs offer potential incentives for the vessels to reduce their bigeye tuna catch. Opportunities for quota transfer could be incorporated into the program design, with potential for new market-based tools to administer and enforce quotas.

Zone-base limits are similar to flag-base limits with respect to challenges in identifying the baseline and agreeing on allocations of that baseline. Transferability of zonal limits between EEZs and fishing gears could also be considered, with the latter requiring development of conversion factors between longline and purse seine fishing gears.

<b>Catch Limit Options</b>	<b>Potential Contribution to Reducing BET Fishing Mortality</b>	<b>Challenges (costs)</b>	<b>Opportunities (benefits)</b>
<b>“Global” TAC for P/S (Olympic quota)</b>	Small group did not consider effectiveness	<ul style="list-style-type: none"> <li>• Implementation problems</li> <li>• Transparency</li> <li>• establishing optimal TAC</li> <li>• previous year abundance uncertainty</li> <li>• race to fish and no allocation</li> <li>• commission agrees to one catch limit tonnage</li> <li>• Controlling catches</li> <li>• Due to Olympic system market oversupplied in short period</li> <li>• Market based measures</li> <li>• Close to real-time reporting</li> </ul>	<ul style="list-style-type: none"> <li>• Simple</li> <li>• First step towards more defined and detailed management option</li> </ul>
<b>Flag-based TACs</b>	Small group did not consider effectiveness	<ul style="list-style-type: none"> <li>• Compliance issues with flag-based reporting</li> <li>• Doesn't recognize coastal rights to the fisheries</li> <li>• Undermines a zone based existing scheme</li> <li>• Establishing baseline catch levels</li> <li>• Aspirational allocations</li> <li>• Disproportionate Burden - explore “credit and mechanism of transferability</li> </ul>	<ul style="list-style-type: none"> <li>• CCM incentives to reduce BET catch</li> <li>• Stabilize market</li> <li>• take away race to fish if managed properly by country</li> <li>• clear responsibility of flag state to manage</li> </ul>
<b>IVQs</b>	Small group did not consider effectiveness	<ul style="list-style-type: none"> <li>• Administration needed to manage the allocation</li> <li>• Transfer of unused quota</li> <li>• Using a common standard not necessary historical data</li> <li>• New vessel entry</li> </ul>	<ul style="list-style-type: none"> <li>• Transfer of unused quota</li> <li>• Vessel and company incentive to reduce BET catch</li> <li>• Stabilization of market</li> <li>• clear responsibility of flag state to manage and sanction</li> <li>• market based measures and sanctions</li> <li>• regional management arrangements</li> <li>• Systems of certification of BET</li> </ul>

<b>Catch Limit Options</b>	<b>Potential Contribution to Reducing BET Fishing Mortality</b>	<b>Challenges (costs)</b>	<b>Opportunities (benefits)</b>
<b>Zone Based Limits for EEZ/Flagged based Limits HS</b>	Small group did not consider effectiveness	<ul style="list-style-type: none"> <li>• Establishing baseline catch levels</li> <li>• Aspirational allocations</li> <li>• Spatial and time period</li> </ul>	<ul style="list-style-type: none"> <li>• Compliments existing measures</li> <li>• Moves towards transferability between gear types</li> <li>• Coastal states and flag states collect operational flag data</li> <li>• Preserves Coastal and Flag States rights</li> <li>• Systems of certification of BE</li> </ul>
<b>Transferability between Gear Based Fishery</b>	Small group did not consider effectiveness	<ul style="list-style-type: none"> <li>• Conversion between gear type</li> </ul>	<ul style="list-style-type: none"> <li>• Managing stock as a whole</li> <li>• Opportunity to search for operational efficiencies throughout the WCPO BET fishery</li> </ul>

### **Discussion Points:**

- It was recognized that the purse seine fishery is largely managed through a zone-based approach using the VDS, and a layering of flag-based limits could be incompatible with the VDS.
- With regards to what role the WCPFC could provide in relation to IVQs, it was acknowledged that the Commission could provide a role to notify which vessels have reached their limits; however, it was recognized that this could also occur at the regional level with FFA or PNA.

#### **4.1.3. Gear Modification Measures**

The small group identified that most gear modification options would need to be tied to a bigeye tuna TAC to incentivize implementation. The group came to the conclusion that the survivability of releasing juvenile bigeye tuna fish swimming to the top of the net would likely be quite low, and would be operationally difficult, so this was not viewed as viable option.

The group also discussed low-profile FADs (shallower sub-surface structure) shallower than the industry standard of approximately 50 meters. Differential effects across the Convention area would be expected, but shallower FAD structure could increase drifting speeds, having an effect on operations. However, there is industry interest in FAD design, with recent movement toward buying pre-constructed FADs, thus, opportunities to work with FAD vendors could exist in the future.

Light and sound stimuli were discussed, but the potential contribution of this to reducing bigeye tuna mortality is unknown, and it is costly to study.

Net depth was evaluated, but the conservation benefit appears to be limited. Most of the potential benefits to bigeye tuna conservation lies in echosounder improvement. The current state of the technology does not allow for clear species identification, whereas only large bigeye tuna aggregations are currently detectable. In the future, there could be a penalty for a set with a large proportion of bigeye tuna, if the species composition of the aggregation is known.

The most promise is larger mesh size net (300 mm +) at the bottom of the net near the chain line, allowing smaller fish to escape. Japanese researchers have produced positive results using large mesh to facilitate the release of small fish. Typical mesh size used in US and Taiwanese operations is 240-260 mm, where these fleets use a nylon net as opposed to the knotless net used by Japanese vessels. However, if larger mesh sizes increase the sinking speed of nets, larger bigeye tuna maybe caught on FADs when otherwise they would have detected and escaped a slower sinking net. Faster net sinking speeds could improve free-school fishing, which would provide benefits.

<b>Gear Modification Options</b>	<b>Potential Contribution to reducing BET fishing mortality</b>	<b>Challenges (costs)</b>	<b>Opportunities (benefits)</b>
<b>Releasing top layer of catch</b>	Unlikely	<ul style="list-style-type: none"> <li>• More research needed</li> <li>• Need TAC</li> <li>• Enforceability</li> <li>• Survivability</li> <li>• Operational slow down</li> </ul>	<ul style="list-style-type: none"> <li>• Outside chance of small bigeye surviving if you could get them out</li> </ul>
<b>Low profile FADS</b>	Possible	<ul style="list-style-type: none"> <li>• More research</li> <li>• E vs. W differences</li> <li>• Effects FAD drift</li> </ul>	<ul style="list-style-type: none"> <li>• Simple</li> <li>• Industry interest in FAD design</li> <li>• Move toward buying from vendors</li> </ul>
<b>Light and Sound differences</b>	Unknown	<ul style="list-style-type: none"> <li>• More research</li> <li>• Costly to study</li> <li>• Need TAC</li> </ul>	<ul style="list-style-type: none"> <li>• Identification of repelling or attracting species</li> <li>• Japan has best captivity environment</li> </ul>
<b>Net depth</b>	Limited	<ul style="list-style-type: none"> <li>• More research</li> <li>• Needs TAC</li> <li>• Costs to modify gear</li> <li>• Enforceability</li> <li>• Reduces total catch</li> <li>• Impacts on FS fishing; more FAD fishing if only shallow nets?</li> </ul>	<ul style="list-style-type: none"> <li>• Captain experience suggests net depth is critical</li> <li>• Some potential for BET escape by setting later in morning</li> </ul>
<b>Echosounder improvements</b>	Possible, in some areas, if tech is good enough	<ul style="list-style-type: none"> <li>• Technology is limited at present</li> <li>• More research</li> <li>• Need TAC</li> <li>• Need large BET aggregations to notice they are there; 25% +</li> </ul>	<ul style="list-style-type: none"> <li>• Pre-set identification</li> <li>• Ability of technology could make a measure feasible (e.g. penalty for sets w/ 25% + BET)</li> </ul>
<b>Larger mesh size</b>	Possible	<ul style="list-style-type: none"> <li>• More research needed</li> <li>• Accurate measurement of impact on overall catch</li> <li>• Knotless (Japan) versus normal nylon (US) net behavior</li> <li>• Gilling w/ FAD sets if made to early</li> <li>• More large BET caught w/ quick net drop and depth</li> </ul>	<ul style="list-style-type: none"> <li>• Reducing BET catch</li> <li>• Consistency in larger fish size</li> <li>• Advantage for free school fishing <ul style="list-style-type: none"> <li>○ Quick drop</li> <li>○ Quick purse</li> </ul> </li> </ul>



### **Discussion Points:**

- It was identified that skipper preference plays a major role in the size of mesh used.
- A view was provided that tuna detect the net when it is coming down or up from them, and it seems improbable that a large mesh size would have conservation to benefit to bigeye tuna.
- It was noted that the EU purse seine vessels will be collaborating with SPC scientists on researching the effect of low-profile FADs that have sub-surface structure.
- It was reiterated that regulating net depth could be effective if fishing was only conducted on FADs; however, the same net is used for school fishing, so limiting net depth would reduce school fishing efficiency.
- It was noted that the time of set should be investigated with respect to catch rates on various tuna species, with potential linkages to net detection. FAD sets are typically done just before dawn, so a little after dawn is when the net starts to become visible.

#### **4.1.4 FAD-Based Options**

A participant in the small group reported on the small group's consideration of FAD-based options. With regards to the FAD closure, it is having an impact, but the contribution to eliminating bigeye tuna overfishing depends on the length of the closure and compliance. The measure is relatively easy to monitor, relying heavily on observer information. Enforcement on the other hand is the vessel's flag state responsibility, but very few countries are sanctioning their vessels for non-compliance with the FAD closure. The WCPFC needs to develop penalties to the FAD closure that could be applied consistently across the WCPO. The current exemptions to the FAD closure serve to undermine its effectiveness. Another aspect that is likely undermining the FAD closure is the deployment and retrieval of FADs by other, 'non-fishing' vessels that service the fleet; unfortunately this activity is very difficult to monitor. Another drawback is that vessel profitability decreases during FAD closure. Establishing two FAD closure periods could potentially address economic issues, but may also weaken the measure. Electronic reporting could enhance the monitoring of the FAD closure.

With respect to FAD set limits, challenges and opportunities are similar to the FAD closure; however, this management option is more complex in relation setting the total FAD limit and allocating FAD limits. For example, allocations could be based flag state history, zone-based, or by vessel. The monitoring of FADs needs improvement, with electronic reporting holding some potential benefits. Currently, the time it takes to address noncompliance also needs to be improved. FAD limits provide greater flexibility to operators, allowing them to choose when to make a FAD set or not.

The group also considered FAD pricing mechanisms. The impact of FAD pricing on bigeye tuna conservation is unknown, and dependent on price and whether it is a stand-alone measure or combined with other measures. A challenge to FAD pricing is that it treats all FAD sets the same, whereas some FAD sets might not have any bigeye tuna versus others with high percentages of bigeye tuna. In addition, FAD pricing would add operational costs to the fleet. An opportunity to the mechanism is that it could be fine-tuned to reflect the species composition of

the set, which could also lead to improvements in pre-set species identification technology. Another benefit is that could contribute to addressing SIDS disproportionate burden issues. Allocation of FAD sets under a pricing system may be difficult. The need to register monitor the high number of existing FADs would also be difficult.

The group felt that removing FADs prior to the FAD closure was impossible due to the large number deployed.

<b>FAD-based Options</b>	<b>Potential Contribution to reducing BET fishing mortality</b>	<b>Challenges (costs)</b>	<b>Opportunities and solutions (benefits)</b>
<b>FAD closure</b>	Proportional to the length of closure and level of compliance. 6 months roughly removes 50% of overfishing.	<ul style="list-style-type: none"> <li>• Monitoring relies on observer data</li> <li>• Enforcement relies on flag States</li> <li>• Cost</li> <li>• ineffectiveness if not consistently implemented by every vessel (exemptions etc.)</li> <li>• Undermined by deployment from “other types” of vessels during the closure – resulting in surges of production at the end of the closure – but this is almost impossible to monitor</li> <li>• Impacts on YFT needs to be monitored – including impacts on market price from increased supply</li> <li>• Lower CPUE and higher costs during FAD closure – less profitability</li> </ul>	<ul style="list-style-type: none"> <li>• Predictability of outcomes</li> <li>• Operational and financial impacts could be reduced by splitting up closure period (may reduce effectiveness)</li> <li>• Opportunities growing for real time reporting (e-reporting and VMS)</li> <li>• Consistent implementation and harmonization/equity of penalties by each CCM would be a better deterrent</li> <li>• Reduced small catch of YFT and SKJ likely to deliver stock benefits.</li> <li>• Larger fish generally attract higher price</li> </ul>
<b>FAD set limits</b>	Proportional to the agreed limits	<ul style="list-style-type: none"> <li>• As above</li> <li>• Allocation – who holds the limits? Total Limit, Flag States, Coastal States, vessels?</li> <li>• And after that – do the limit holders have the resources to adequately monitor and administrate</li> <li>• Real time monitoring is more important than for a set closure</li> <li>• Monitoring needs to be improved</li> <li>• Enforcement needs to be conducted more rapidly</li> <li>• Costs</li> </ul>	<ul style="list-style-type: none"> <li>• As above</li> <li>• But greater flexibility for vessel operators to spread FAD use throughout the year.</li> <li>• Should be less impacts on market price etc.</li> </ul>
<b>FAD set pricing</b>	Unknown – variable depending on price and whether it is standalone or complements others	<ul style="list-style-type: none"> <li>• “Indiscriminate” approach that treats all FAD sets the same – some don’t result in the same level of impact.</li> <li>• Increases operational costs</li> </ul>	<ul style="list-style-type: none"> <li>• Could be better developed to have a variable price based on the results of the set. Could encourage uptake of better technology to discriminate sets</li> <li>• Contributes to addressing disproportionate burden</li> </ul>

<b>FAD-based Options</b>	<b>Potential Contribution to reducing BET fishing mortality</b>	<b>Challenges (costs)</b>	<b>Opportunities and solutions (benefits)</b>
<b>FAD Limits</b>	Unknown	<ul style="list-style-type: none"> <li>• Allocation issues as above</li> <li>• Registering and Monitoring 85,000+ FADs...</li> </ul>	<ul style="list-style-type: none"> <li>• Better ability to monitor FAD deployment during a closure</li> <li>• Potential to contribute to compliance monitoring (proximity alerts)</li> </ul>
<b>Anchored FAD (Management Plans)</b>	Possible positive impact, additional data required	<ul style="list-style-type: none"> <li>• Anecdotal advice about high bigeye catch rates in some areas (such as HSP)</li> <li>• Fish aggregated to a/FADs generally very small</li> </ul>	<ul style="list-style-type: none"> <li>• In some areas (Solomon a/w) bigeye bycatch from a/FADs is very low</li> </ul>
<p><b>Remove FADs before closure -</b> Not considered feasible – too many FADs in the water. But similar result could be achieved by prohibiting deployment for a given period before the closure commences</p>	Probably moderate	<ul style="list-style-type: none"> <li>• Enforceability and monitoring of FADs is difficult, especially for “other” vessel types.</li> </ul>	<ul style="list-style-type: none"> <li>• Removes the huge catch on well aggregated FADs immediately following the FAD closure and means several weeks before newly deployed FADs accumulate fish</li> </ul>

## **Discussion Points:**

- It was recognized that there should be consideration of prohibiting the deployment of FADs 1 to 2 months prior FAD closure period to potentially reduce the number of FADs that could be “soaking” during the closure period.
  - It was noted that the monitoring FAD deployments is challenging, especially when the non-purse seine support vessels are deploying the FADs. These vessels typically do not carry observers and it is impossible to tell from VMS if a FAD was deployed.
  - It was identified that a FAD registration and tracking program would help address this situation, but such a system would have to be large to accommodate the high number of FADs.
  - It was acknowledged that it typically takes 30-40 days for tuna to aggregate to a drifting FAD.
- It was identified that one potential option to address the issue would be the combination of a seasonal FAD closure and a total closure.
- A view was expressed that limiting FAD set limits is preferred rather than limiting the number of deployed FADs, because FADs are only harmful to bigeye tuna when they are set upon, not when they are drifting.
- A countering view was provided that limiting the number of FADs deployed is important because high FAD density improves a vessel’s decision making on where to fish, which could result in higher levels of bigeye tuna mortality. KS Lee commented that no measure is going to be effective unless there is an immediate freeze on fishing vessel capacity. Martini agreed that the issue of capacity is important and relevant to potential effectiveness of any measure.
- Regarding anchored FADs, it was noted that the anchored FADs in archipelagic waters of the Solomon Islands have been demonstrated to have lower bigeye tuna catch rates compared to other areas in the region.
  - It was noted that the same conclusions cannot be drawn for the anchored FADs used by Philippine vessels, where there it is believed that these vessels are catching bigeye tuna fishing on anchored FADs in one of the western High Seas Pockets, but that there is little information provided to the Commission from these vessels.

#### **4.1.5 Market-Based Measures**

Dale Squires presented on the small group's consideration of market-based measures. They divided the approach into measures that are directly addressing small bigeye tuna and those that were related more towards information, markets and the supply chain. Supply chain measures primarily impacts the catch that reaches developed markets, while direct measures that alter fishing behavior tend to have more global effect. Generally, there are two types of incentives. The first incentive is more immediate, and it directly impacts behavior. The second type of incentive is longer term and influences technological change.

The first option evaluated was pricing FAD sets, which could result in positive outcomes. For example, FAD pricing likely creates an economic incentive more closely related to the conservation objective as opposed to effort or capacity limits. This should work to induce technological change over the long term. Challenges associated with FAD pricing is that it adds another market which could have interactions with the market associated with the VDS.

A bigeye tuna credit system was discussed. In the Alaskan pollock fishery, which is a major industrial fishery, there is a transferable credit system for bycatch species that is less stringent and more flexible than a property right system. Such a system could be developed for bigeye tuna, but allocations of a TAC would be required.

Other market-based options that were evaluated include a) full catch retention, 2) tax or charge on catching bigeye tuna, 3) eco-labeling, and 4) price differentials for small bigeye tuna.

<b>Market-Based Options</b>	<b>Potential Contribution to reducing BET fishing mortality</b>	<b>Challenges (costs)</b>	<b>Opportunities (benefits)</b>
FAD Set Fees/Pricing	<p>A potential contribution to bigeye conservation, but depends on items such as:</p> <ul style="list-style-type: none"> <li>- Whether price and quantity offered serve to reduce total annual fishing effort.</li> <li>- The reliability and timing of reporting</li> <li>- Effectiveness of complementary measures on the high seas</li> </ul>	<ul style="list-style-type: none"> <li>• Requires reliable bigeye biomass measures – inclusive of the EPO and the WCPO.</li> <li>• Requires FAD set prices to be pegged at levels that result in effort levels that improved bigeye abundance.</li> <li>• Initial pricing will be largely guesswork.</li> <li>• The relationship between price levels and the number of FAD sets purchased (the demand for FAD sets) is likely to be nonlinear and possibly discontinuous and can be determined only through a trial and error process.</li> <li>• The demand for FAD sets is dynamic and will likely shift with annual abundance and the Bangkok price of tuna.</li> <li>• The elasticity (slope) of the demand for FAD sets will determine both the conservation effectiveness of price changes and the incremental revenue received by PNA members – inelastic demand would imply that price changes have a small incremental conservation impact while having a large revenue impact – elastic demand would imply that price changes have a large incremental conservation impact and a small incremental revenue impact.</li> <li>• Priced FAD sets are likely to encourage sets only on FADs with the highest biomass of tuna.</li> <li>• Input oriented measures/limits provide weaker conservation incentives than do output oriented measures/limits.</li> <li>• Complicated and uncertain compatibility with VDS. For best results both FAD and VDS require full transparency, which is lacking.</li> <li>• Encourages school setting and thus results in higher fishing pressure on yellowfin.</li> <li>• Accurate monitoring of the use and transfer of FAD sets is difficult and costly.</li> </ul>	<ul style="list-style-type: none"> <li>• Creates economic incentives more closely related to reducing FAD sets bigeye mortality than does the VDS alone.</li> <li>• Will induce bigeye saving innovation and technology changes.</li> <li>• Will provide increased revenue to PNA countries; thus, addressing DB.</li> <li>• Fees for fishing on FADs in international waters could be used to fund Commission projects that address DB.</li> <li>• Creates an incentive to avoid FAD associated small schools; thus, providing ecosystem benefits and biodiversity.</li> <li>• If FAD sets could be paid for after the fact and FAD set fees were directly tied to FAD set size both PNA and industry would benefit.</li> </ul>

<b>Market-Based Options</b>	<b>Potential Contribution to reducing BET fishing mortality</b>	<b>Challenges (costs)</b>	<b>Opportunities (benefits)</b>
Full Tuna Retention	Likely to have little impact on bigeye catch rates or conservation	<ul style="list-style-type: none"> <li>• Creates both direct and indirect costs that potentially might alter the behavior of producers in uncertain ways</li> <li>• May not be a market for some species</li> <li>• May disrupt local seafood markets</li> <li>• Will likely have positive impacts on food security</li> <li>• Requires increased port sampling</li> </ul>	<ul style="list-style-type: none"> <li>• Creates an incentive to lower all bycatch presumably including bigeye</li> <li>• Improves multispecies data because of increased port sampling</li> <li>• Causes harvesting to be more ecosystem based and thus fosters ecosystem level management</li> </ul>
Small Bigeye Tuna Tax and Return to Vessel Owners	<p>A potentially high contribution to bigeye conservation but difficult implementation.</p> <p>Vessels/firms would pay a charge for bigeye catch. These proceeds would be returned to the vessels/firms at the end of the year in reverse proportion to the amount of bigeye harvested.</p>	<ul style="list-style-type: none"> <li>• Industry resistance to fees and taxes and other negative incentives that raise costs</li> <li>• PNA resistance to dilution of potential VDS revenue</li> <li>• Difficult to impose tax at the proper level to accurately impact bigeye catch</li> <li>• Requires periodic adjustment based on ex-vessel prices and estimates of bigeye biomass</li> <li>• Requires vessel log and cannery species verification.</li> <li>• Requires an international entity to collect and distribute the tax proceeds</li> <li>• Complicated and incentives must reach the fishing decision makers at the vessel level</li> <li>• Requires accurate identification of bigeye and catch composition at some point in the harvesting or offloading process</li> </ul>	<ul style="list-style-type: none"> <li>• Directly prices small bigeye tuna and creates a strong incentive (both “carrot” and “stick”) to avoid the harvest of small bigeye</li> <li>• Does not require exacting measures of bigeye biomass</li> </ul>
Incentive Payments Not to Catch Bigeye	Potentially high contribution to bigeye conservation. Vessels are paid not to catch bigeye.	<ul style="list-style-type: none"> <li>• Requires a long term sustainable source of funding</li> <li>• Requires limited entry to the fishery</li> <li>• Some funding sources can result in undesired overall social and economic impacts</li> <li>• Requires accurate identification of bigeye and catch composition at some point in the harvesting offloading process</li> </ul>	<ul style="list-style-type: none"> <li>• A direct payment/reward for not harvesting bigeye above a predetermined maximum</li> <li>• Does not require exacting measures of bigeye biomass</li> </ul>



<b>Market-Based Options</b>	<b>Potential Contribution to reducing BET fishing mortality</b>	<b>Challenges (costs)</b>	<b>Opportunities (benefits)</b>
Small Bigeye Credit System	Potentially high contribution to bigeye conservation. Catch credits are assigned when a vessel reduces its bigeye catch below a given quota level. Credits are transferable and can be used by vessels not meeting their bycatch quota level, or the credits can be banked into future years.	<ul style="list-style-type: none"> <li>• Requires accurate assessment of bigeye biomass and calculation of TAC and IVQs, and allocation of quotas to vessels or groups of vessels.</li> <li>• Requires multiyear quotas with the potential for passing forward any overages.</li> <li>• Difficult to implement with in an international fishery with two gear types, one with bigeye bycatch and one with bigeye target catch.</li> <li>• Requires accurate identification of bigeye and catch composition at some point in the harvesting offloading process.</li> </ul>	<ul style="list-style-type: none"> <li>• Provides incentives (both reward and penalty) to avoid bigeye at the individual vessel level in years of high abundance as well as in years of low abundance.</li> <li>• The prices paid by vessels for transferable credits will provide an accurate shadow price for small bigeye.</li> <li>• Provides an incentive to develop bycatch saving technology and innovation.</li> <li>• Avoids some of the complexity associated with ITQs because a bycatch credit is not the same as a property right.</li> <li>• Used in the Alaskan Pollock fishery.</li> <li>• Can easily be combined with an area closure regime.</li> <li>• The industry as a whole does not pay for mandated bigeye avoidance because the credit buying vessel's cost equals the credit selling vessel's revenue.</li> <li>• Bycatch per unit of target catch is likely to be lower under a transferable credit system than under an IVQ system.</li> </ul>
Low Ex-vessel Pricing for Bigeye	Moderate contribution to bigeye conservation depending on the degree of price differentiation between yellowfin and bigeye and between size classes.	<ul style="list-style-type: none"> <li>• Requires accurate identification of bigeye and catch composition at point of sale.</li> <li>• May impact on food security in some countries at point of sale.</li> <li>• The financial incentive must reach to the decision makers at the vessel operation level.</li> <li>• May encourage high grading if full retention is not adequately regulated.</li> </ul>	<ul style="list-style-type: none"> <li>• A significantly higher price for yellowfin over bigeye creates a financial incentive to avoid bigeye and to improve species identification at point of sale.</li> <li>• A significantly lower price for small fish will discourage their harvest.</li> </ul>

<b>Market-Based Options</b>	<b>Potential Contribution to reducing BET fishing mortality</b>	<b>Challenges (costs)</b>	<b>Opportunities (benefits)</b>
Eco-labeling	<p>Moderate to high contribution to bigeye conservation in high income markets. Premium pricing and marketing of canned tuna in ways that acknowledge certification of bigeye conservation. Labeling examples: “Free School Caught”, “Bigeye Free”, “FAD Free”, etc.</p>	<ul style="list-style-type: none"> <li>• Premium prices for non-bigeye associated harvest may not filter down to decision makers at the vessel level.</li> <li>• Markets with high price elasticity, low income elasticity, and many substitutes will incentivize lower price premiums and lower market share for eco-labeled products. In these markets eco-labeling may work against bigeye conservation.</li> <li>• May provide an initial benefit to bigeye conservation, but as certification becomes standard and not unique the benefit will shrink.</li> <li>• Creates higher costs in the supply chain that must be compensated by volume and the eco-labeled price premium. This premium is likely to shrink over time.</li> </ul>	<ul style="list-style-type: none"> <li>• If price premium is transmitted from finished markets to ex-vessel prices then vessels will be incentivized to avoid bigeye.</li> <li>• Creates public awareness of a conservation problem.</li> <li>• Can contribute to boycotts and eco-friendly market campaigns that result in greater demand for bigeye free products.</li> <li>• Can lead to and encourage buyer commitments to avoid and discourage the purchase of bigeye and products containing bigeye.</li> </ul>

## **Discussion Points:**

- On the topic of a self-reported FAD fee, it was recognized a problem with self-reporting is that the reliability of the self-reported forms changes over time, which could cause statistical bias in the data.
- A view was provided that rewards should be offered for vessels that are doing the right thing, such as lowering fishing mortality on BET by fishing on free-schools, and perhaps there could be a different price structure for rewarding good fishing performance.
  - It was acknowledged that it is common to think of negative incentives before positive incentives, and further, challenges often arise when considering how to fund positive incentives.
  - It was noted that ecolabeling provides an opportunity to provide positive incentives through the market, but payments may not be consistently transferred to the vessel crew.

## **5. Workshop Wrap-up and Closing Remarks**

Chairman Wright presented a summary of the workshop, reviewing the information provided in the presentations and identified key points. He noted the workshop objectives to develop a set of recommendations and evaluate potential management measures that reduce fishing mortality on bigeye tuna. The small groups allowed for more in-depth evaluation of the various management options with respect to the workshop objectives. Participants were asked to provide a few key takeaways from the workshop.

## **Discussion Points:**

- The point was raised on the need for the WCPFC and IATTC to coordinate management regimes given the Pacific-wide distribution of bigeye tuna, fleets that operate in both areas, and canneries on both sides of the Pacific that accept fish from both areas.
  - It was noted that one important difference to recognize between the management approaches in the WCPFC and IATTC are the rights-based schemes implemented in the WCPO as a result of Pacific Island coordination and how these rights-based measures are being utilized to drive agreement on the need for the WCPFC to develop compatible measures.
- It was identified that a major issue going forward for any management regime is the ability to correctly identify the juvenile catch of bigeye tuna in the purse seine fishery.
  - The importance of collaboration with countries that have canneries to assist in the collection of accurate catch data was noted.
- It was suggested that there is a need to consider the contribution of longline fisheries to bigeye tuna overfishing and to strike a balance between purse seine and longline fishing on the necessary reductions in bigeye tuna fishing mortality.
- A view was provided that no management measure is going to be effective unless fishing capacity in the WCPFC is addressed and entry into the fishery is closed.
  - It was noted that capacity management is a sensitive issue with respect to SIDS development aspirations.

- It was recognized that there is an urgent need to investigate what the high bigeye tuna catching vessels are doing differently and how that might bring a greater understanding to solving the problem.
- It was identified that there is the need to hear from industry on how they are looking at addressing the bigeye tuna issue.
- It was recognized that work on the bigeye tuna hotspot identification is important and should continue, and the need to incorporate the effects of echosounder FADs on the catchability of bigeye tuna.
- A view was expressed that the result of the Apia WCPFC meeting was disappointing, and that there is a need to change the way the commission does its work if it is expected to get a measure through in a week's time.
  - It was noted that the workshop has provided an informal setting for participants including industry to share their views and has advanced the dialogue; however, there is a need for additional stakeholders to participate in this type of forum including the longline fishing industry more representation from SIDS.
- It was recognized that there has been science and monitoring related exchanges between the IATTC and WCPFC, but that the workshop was the first opportunity to share management experiences between the two Commissions.
- There was general agreement on the need to continue to discuss options to addressing the bigeye tuna problem.
- Glen Joseph offered to host for a second workshop to be held in Majuro with a goal to keep the momentum going and an objective of developing management options that will be agreeable and meaningful for consideration by the December meeting of the WCPFC.

Drew Wright closed the workshop by acknowledging the recent passing of Dr. Robin Allen, recognizing his global contributions to tuna management and his friendship to many workshop participants.

Kitty Simonds thanked Drew Wright for chairing the meeting and thanked all participants for their hard work and contributions to the workshop.

## Attachment 1- List of Participants

<b>Last Name</b>	<b>First Name</b>	<b>Title</b>	<b>Agency or Company</b>
Akatsuka	Yuujiro	Assistant Director	Fisheries Agency Government of Japan
Bigelow	Keith	Research Fish Biologist	National Marine Fisheries Service (PIFSC)
Bixler	Kevin	Vice President	Chicken of the Sea
Callaghan	Paul	SSC Member	Western Pacific Fishery Management Council
Calvo	Daniel	Associate	OPAGAC
Chan	Valerie	Fishery Policy Analyst	National Marine Fisheries Service (PIRO)
Chikami	Stuart	Manager	Western Pacific Fisheries Inc.
Chou	Max	President	South Pacific Tuna Corp
Clarke	Ray	Fishery Biologist	National Marine Fisheries Service (PIRO)
Compean	Guillermo	Director	Inter-American Tropical Tuna Commission
Da Rosa	Larry	Fleet Manager	Tradition Mariner LLC
Dalzell	Paul	Senior Scientist/ Pelagic Program Officer	Western Pacific Fishery Management Council
Deriso	Rick	Chief Scientist	Inter-American Tropical Tuna Commission
Hallman	Brian	Executive Director	American Tunaboat Association
Hampton	John	Ocean Fisheries Programme Manager	Secretariat of the Pacific Community
Harley	Shelton	Principal Fisheries Scientist	Secretariat of the Pacific Community
Herrera	Miguel	Data Manager	OPAGAC
Hu	Teresa	Chairman's-Assistant	Taiwan Purse Seiner Association
Humphreys	Jim	U.S Director	Marine Stewardship Council
Itano	David	Consultant	Western Pacific Fishery Management Council
Jackson	Susan	President	International Seafood Sustainability Foundation
Joseph	Glen	Director	Marshall Islands Marine Resources Authority
Karnella	Charles	International Fisheries Division Administrator	National Marine Fisheries Service (PIRO)
Kawamoto	Taro	Director	Kyokuyo Suisan Co., ltd
Keliber	Pierre	SSC Member	Western Pacific Fishery Management Council
Kim	Anthony	Manager	SILLA.CO.,LTD
Kingma	Eric K	International Fisheries/ NEPA Coordinator	Western Pacific Fishery Management Council
Koehler	Holly	Vice President, Policy and Outreach	International Seafood Sustainability Foundation
Lee	K.S "Tuna"	Executive Director	SILLA.CO.,LTD
Liu	Xiaobing	Division Director	Bureau of Fisheries and Fishery Law Enforcement
Manarangi-Trott	Lara	Compliance Manager	Western and Central Pacific Fisheries Commission
Martin	Sean	President	Hawaii Longline Association

Martini	Angela	International Relations Officer	European Commission
Moss	Rhea	Chair	Western and Central Pacific Fisheries Commission
Norris	Wez	Deputy Director General	Pacific Islands Forum Fisheries Agency
Owens	Matt	Director, Sustainability	Tri Marine Group
Pangelinan	Eugene	Deputy Director	National Oceanic Resource Management Authority
Restrepo	Victor	Vice President, Science	International Seafood Sustainability Foundation
Rice	McGrew	Council Member	Western Pacific Fishery Management Council
Schaefer	Kurt	Head of Biology and Ecosystem Program	Inter-American Tropical Tuna Commission
Sibert	John	SSC Member	Western Pacific Fishery Management Council
Simonds	Kitty	Executive Director	Western Pacific Fishery Management Council
Sousa	Jim	Director	GS Fisheries Inc.
Squires	Dale	Industry Economist	National Marine Fisheries Service (SWFSC)
Teo	Feleti	Executive Director	Western and Central Pacific Fisheries Commission
Trujillo	Rafael	Executive Director	National Chamber of Fisheries
Tsai	Jason	Staff	Taiwan Purse Seiner Association
Tsai	Ting Pang (James)	Chairman	Taiwan Purse Seiner Association
Woo	Densen	Manager	Shanghai KaiChuang Deep Sea Fisheries Ltd., Co.
Wright	Drew (Chair)	Executive Secretary	CCAMLR

## Attachment 2- Workshop Agenda



WESTERN  
PACIFIC  
REGIONAL  
FISHERY  
MANAGEMENT  
COUNCIL

### WCPO Purse Seine Bigeye Management Workshop

#### Annotated Agenda

April 8-10, 2015  
Honolulu, Hawaii  
Harbor View Center at Pier 38

#### Wednesday 8 April 8:30 am - 5:00 pm

#### 1. Opening of Workshop

##### 1.1 Welcome and Introductions

Drew Wright (Chair)

##### 1.2 Opening Remarks

Kitty Simonds (WPFMC)

##### 1.3 Workshop Agenda and Outcomes

Chair

The workshop Chair will provide an overview of the workshop agenda and expected outcomes. He will explain that the objectives of the workshop include to:

1. develop a set of recommendations that will identify measures for the reduction bigeye tuna fishing mortality by purse seine gear, and
2. evaluate management measures with respect to conservation benefits, implementation impacts, and enforceability.

#### 2. Background Information

##### 2.1 Current Bigeye Management Measures

Presentations will review the existing conservation and management measures that relate to bigeye tuna fishing mortality.

2.1.1- WCPO - Lara Manarangi – Trott (WCPFC)

2.1.2- EPO - Guillermo Compeán (IATTC)

#### Break 10:30 -11:00

## **2.2 BET Stock Status and PS Bigeye Catch Trends**

The status of bigeye tuna in the WCPO and EPO with a focus on PS bigeye tuna catch trends both temporally and spatially will be summarized.

2.2- WCPO – John Hampton (SPC)

2.3- EPO – Rick Deriso (IATTC)

**Discussion**

Chair

## **2.3 Industry Perspectives**

During this section, participants from the fishing and processing industries will provide their perspective on the management of bigeye tuna in the Pacific. Participants will highlight measures that they think are working or not working as well as share ideas on best practices to avoid or reduce incidental catch of bigeye tuna by purse seine vessels.

2.3.1 Kwang-Se Lee (Korean industry)

**Discussion**

Chair

**Lunch 12:30-1:30**

**Presentation by Victor Restrepo:**

**“Capacity of the Large-Scale Tropical Tuna Purse Seine Fishing Fleets (as of April 2015)”**

## **3. WCPO PS BET Management Options**

A series of presentations will serve as introductions for workshop participants to consider each of the following management options individually and collectively:

### **3.1 Temporal-Spatial Measures**

3.1.1- John Sibert (SEAPODYM analysis)

3.1.2- Shelton Harley (BET ‘hot spot’ identification)

3.1.3- Kurt Schaefer (IATTC experience)

**Discussion**

Chair



Workshop attendees will be invited to discuss pros and cons associated with spatial-temporal closure options with emphasis on conservation benefit, implementation impacts, and enforceability.

### **3.2 Bigeye Catch Limits**

3.2.1- Dave Itano- (Pre-set identification of bigeye tuna)

3.2.2- Rick Deriso – (Vessel specific analysis in the EPO)

3.2.3- Shelton Harley- (Catch variability across vessels and sets in the WCPO)

3.2.4- Valerie Chan (Implementation issues of PS catch limits)

**Discussion**

Chair

## **Thursday 9 April 8:30 am - 5:00 pm**

### **3.3 Gear Modifications and Other Technical Options**

3.3.1- Victor Restrepo (ISSF research)

3.3.2- Dave Itano (Net depth limits)

3.3.3- Yuujirou Akatsuka (Japan's PS FAD set reductions in the WCPO)

3.3.4- Taro Kawamoto (Improving free school fishing efficiency)

**Discussion**

Chair

## **Break 10:30-11:00 am**

### **3.4 FAD-based Issues**

3.4.1- John Hampton (Effects of FAD measures in the WCPO (2009-2014))

3.4.2- Wez Norris (Using financial mechanisms to influence fishing behavior)

**Discussion**

Chair

### **3.5 Market-based Initiatives**

Market based measures will be explored including, fish pricing, traceability, tuna product species identification, ecolabels/certification, and other options. Views on market driven incentives and the types of incentives that might be offered to vessel operators to reduce BET catches will be discussed. Information will also be provided showing market trends of FAD free versus FAD associated tuna and the identification of differences in American versus European canned tuna markets. Purchasing decisions by processors:

3.5.1- Asia/Pacific (Kevin Bixler- Chicken of the Sea)

3.5.2- Latin America (Susan Jackson- ISSF)

3.5.3- Atlantic/Indian Ocean (Susan Jackson)

3.5.4- Jim Humphries (Marine Stewardship Council- Ecolabels and other market driven incentives)

3.5.5- Matt Owens (Tri Marine- Vessel incentives for supplying FAD-free fish)

### **Discussion**

Chair

### **3.6 Other considerations**

Workshop participants will review practices and issues not specifically considered under previous agenda items. This may include discussion of effort management mechanisms and other matters of global concern such as capacity management. In addition, this item will also provide an opportunity to consider priority issues for future research to strengthen advice available for management decision-making.

**Friday 10 April 8:30 am – 3:30 pm**

**4. Workshop Recommendations and Outcomes**

Chair

Workshop participants will prioritize management options and recommendations they support for further consideration by the WCPFC, IATTC, or sub-regional organizations. The outcome of the workshop will be a report of the proceedings that will identify the pros and cons of each management measure considered including its conservation benefits, implementation impacts, and enforceability.

**Lunch 12:30-1:30 pm**

**4. Workshop Recommendations and Outcomes (Continued)**

**5. Workshop Wrap-up and Closing Remarks**

Susan Jackson

Chair

**Finish 3:30 pm**